

NVR

User's Manual

Model: 4-CH

8-CH

16-CH

32-CH

64-CH

Before attempting to connect or operate this product,
please read these instructions carefully and save this manual for future use.

NVR_v1.2.0_20221027

CAUTION

TO REDUCE THE RISK OF ELECTRIC SHOCK, DO NOT REMOVE COVER.
NO USER SERVICEABLE PARTS INSIDE.
PLEASE REFER SERVICING TO QUALIFIED SERVICE PERSONNEL.

WARNING

TO PREVENT FIRE OR ELECTRIC SHOCK HAZARD, DO NOT EXPOSE THIS
APPLIANCE TO RAIN OR MOISTURE.

NOTE: This equipment has been tested and found to comply with the limits for a Class "A" digital device, pursuant to Part 15 of the FCC Rules. These limits are designed to provide reasonable protection against harmful interference when the equipment is operated in a commercial environment. This equipment generates, uses and can radiate radio frequency energy and, if not installed and used in accordance with the instruction manual, may cause harmful interference to radio communications. Operation of this equipment in a residential area is likely to cause harmful interference in which case the users will be required to correct the interference at their own expense.

FCC Caution: To assure continued compliance, use only shielded interface cables when connecting to computer or peripheral devices. Any changes or modifications not expressly approved by the party responsible for compliance could void the user's authority to operate this equipment.

This Class A digital apparatus meets all the requirements of the Canadian Interference Causing Equipment Regulations.



LIMITATION OF LIABILITY

- THIS PUBLICATION IS PROVIDED “AS IS” WITHOUT WARRANTY OF ANY KIND, EITHER EXPRESS OR IMPLIED, INCLUDING BUT NOT LIMITED TO, THE IMPLIED WARRANTIES OF MERCHANTABILITY, FITNESS FOR ANY PARTICULAR PURPOSE, OR NON-INFRINGEMENT OF THE THIRD PARTY’S RIGHT.
- THIS PUBLICATION COULD INCLUDE TECHNICAL INACCURACIES OR TYPOGRAPHICAL ERRORS. CHANGES ARE ADDED TO THE INFORMATION HEREIN, AT ANY TIME, FOR THE IMPROVEMENTS OF THIS PUBLICATION AND/OR THE CORRESPONDING PRODUCT(S).

DISCLAIMER OF WARRANTY

IN NO EVENT SHALL THE SUPPLIER BE LIABLE TO ANY PARTY OR ANY PERSON, EXCEPT FOR REPLACEMENT OR REASONABLE MAINTENANCE OF THE PRODUCT, FOR THE CASES, INCLUDING BUT NOT LIMITED TO THE FOLLOWINGS:

- ANY DAMAGE OR LOSS, INCLUDING BUT WITHOUT LIMITATION, DIRECT OR INDIRECT, SPECIAL, CONSEQUENTIAL OR EXEMPLARY, ARISING OUT OF OR RELATING TO THE PRODUCT;
- PERSONAL INJURY OR ANY DAMAGE CAUSED BY INAPPROPRIATE USE OR NEGLIGENT OPERATION OF THE USER;
- UNAUTHORIZED DISASSEMBLE, REPAIR OR MODIFICATION OF THE PRODUCT BY THE USER;
- ANY PROBLEM, CONSEQUENTIAL INCONVENIENCE, OR LOSS OR DAMAGE, ARISING OUT OF THE SYSTEM COMBINED WITH THE DEVICES OF THE THIRD PARTY;
- ANY CLAIM OR ACTION FOR DAMAGES, BROUGHT BY ANY PERSON OR ORGANIZATION BEING A PHOTOGENIC SUBJECT, DUE TO VIOLATION OF PRIVACY WITH THE RESULT OF THAT SURVEILLANCE-CAMERA’S PICTURE, INCLUDING SAVED DATA, FOR SOME REASON, BECOMES PUBLIC OR IS USED FOR THE PURPOSE OTHER THAN SURVEILLANCE.

PRECAUTIONS

- **Please refer all work related to the installation of this product to qualified service personnel or system installers.**
- **Do not operate the appliance beyond its specified temperature, humidity or power source ratings.**

Use the appliance at temperature within $-20^{\circ}\text{C} \sim +65^{\circ}\text{C}$ and humidity below **85%**.
The input power source for this appliance is **+12 VDC**.
Performance and lifetime of hard disk drives are easily affected by heat (used at high temperature). It is recommended to use this appliance at temperature within $+20^{\circ}\text{C} \sim +30^{\circ}\text{C}$.
- **Handle the hard disk drives with care.**

It is possible to damage them if they are moved while their motors are still running. Do not move them just after turning the power on or off (for around 30 seconds).
Protect the hard disk drives from static electricity.
Do not stack them or keep them upright.
Do not use an electric screwdriver to fix them.
- Clean only with dry cloth.
- Do not block any ventilation openings.
- Do not use the appliance near any heat sources such as radiators, heat registers, stoves or other apparatus that produce heat.
- Protect the power cord from being stepped on or pinched particularly at plugs, convenient receptacles and the points where they exit from the apparatus.
- Do not drop metallic parts through slots. This could permanently damage the appliance. Turn the power off immediately and contact qualified service personnel for service.
- Handle the appliance with care. Do not strike or shake, as this may damage the appliance.
- Do not expose the appliance to water or moisture, nor try to operate it in wet areas. Do take immediate action if the appliance becomes wet. Turn the power off and refer servicing to qualified service personnel. Moisture may damage the appliance and also cause electric shock.
- Do not use strong or abrasive detergents when cleaning the appliance body. When the dirt is hard to remove, use a mild detergent and wipe gently.
- Do not overload outlets and extension cords as this may result in a risk of fire or electric shock.
- Please make a note of your settings and save them. This will help when you are required to change the system configuration, or when unexpected failure or trouble occurs.
- Distributing, copying, disassembling, reverse compiling, reverse engineering, and also exporting in violation of export laws of the software provided with this product, is expressly prohibited.

Table of Contents

PRECAUTIONS.....	- 4 -
TABLE OF CONTENTS.....	5
1. PRODUCT OVERVIEW.....	7
2. REMOTE CONTROLLER	7
2.1 REMOTE CONTROLLER (WILL BE SUPPORTED IN THE FUTURE.).....	7
3. INSTALLATIONS	9
3.1 BASIC CONNECTIONS	9
3.2 OPTIONAL CONNECTIONS	11
4. MAIN SCREEN AND BASIC OPERATIONS.....	14
4.1 TEXT INPUT.....	15
4.2 LOGIN AND LOGOUT	15
4.3 BASIC OPERATIONS	16
4.4 DIGITAL ZOOM	17
5. MENU DISPLAY	18
5.1 STATUS DISPLAY	19
5.2 VOLUME CONTROL.....	19
5.3 VIDEO ADJUSTMENT.....	20
5.4 DISPLAY	21
5.5 NETWORK	22
5.5.1 Notification Setup	24
5.5.2 FTP Setup	25
5.5.3 5G/4G/3G Modem Setup	26
5.5.4 Advanced Network Setup.....	27
5.5.5 LAN Setup.....	29
5.6. PTZ CONTROL.....	30
5.7 SYSTEM SHUTDOWN (ADMINISTRATOR)	32
6. SETUP (ADMINISTRATOR)	32
6.1 CAMERA SETUP	33
6.1.1 IPCam Encode Setup.....	36
6.1.2 IPCam Image Setup.....	36
6.1.3 Video Loss Setup	37
6.1.4 Motion/Privacy Mask Setup.....	38
6.2 ALARM SETUP	41
6.3 MAIN/SEQ DISPLAY SETUP	43
6.4 SCHEDULED RECORD SETUP	45
6.5 HDD SETUP.....	47
6.5.1 HDD Format/Clear.....	50
6.5.2 Advanced HDD Setup	53
6.6 PASSWORD SETUP	54
6.7 SYSTEM SETUP	58
6.8 RS-232/485/IR SETUP	60
6.9 OSD SETUP.....	61
7. SEARCH/PLAYBACK/ARCHIVE (ADMINISTRATOR, SUPERVISOR)	62
7.1 SEARCH BY TIME.....	63
7.2 SEARCH BY EVENT / LOG DISPLAY.....	64
7.3 SEARCH ARCHIVED FILES.....	66
7.4 POS SEARCH	67
7.5 PLAYBACK/ARCHIVE FOR SEARCH BY TIME	69
7.6 PLAYBACK/ARCHIVE FOR SEARCH BY EVENT	72

7.7 PLAYBACK FOR ARCHIVED FILES.....	73
7.8 PLAYBACK/ARCHIVE FOR POS SEARCH	73
8. REMOTE ACCESS	74
8.1 PC REMOTE ACCESS.....	74
8.2 PDA/MOBILE PHONE REMOTE ACCESS (CHROME WAP MODE)	- 88 -
APPENDIX A – TIME ZONE TABLE	- 89 -
APPENDIX B – MS-WINDOWS HEM UTILITIES	- 91 -
APPENDIX C – GPS FUNCTION IN REMOTE SOFTWARE WITH GOOGLE EARTH	- 96 -
APPENDIX D – PROTOCOL CONVERTER FOR MULTIPLE POS	- 100 -

1. Product Overview

The network recorders are designed for use within a surveillance system with limited space and combine a hard disk recorder, a video multiplexer, and a web server. This series of digital video/audio recorders are all based on industry-leading front-end to back-end surveillance infrastructure to achieve the highest inter-connectivity and inter-operability. With state-of-the-art system architecture, powerful compression/decompression engine, and intelligent recording algorithms, sixfold operation can be easily achieved without sacrificing the increasing demands of functionality, performance, reliability, and availability in the surveillance industry.

2. Remote Controller

2.1 Remote Controller (Will be supported in the future.)

The remote controller is an optional accessory to ease the user's operations. You can do all the operations by the remote controller instead of the buttons on the front panel. The effective distance is about 10 meters without any obstacle.



1. **MODE Button**

Press this button to toggle between live mode and playback mode in main screen display. In some dialogs, this button is used as a miscellaneous function key. [At playing, this button is used as "slow backward"](#).

2. **SEQ Button**

Press this button to switch to or return from SEQ display mode in main screen display. In some dialogs, this button is used as a miscellaneous function key. [At playing, this button is used as "slow forward"](#).

3. **CALL Button**

Press this button to switch to or return from full screen display of the focus camera in main screen display. In some dialogs, this button is used as a miscellaneous function key.

4. **SEARCH Button**

Press this button to display the search menu in main screen display. In some dialogs, this button is used as a miscellaneous function key.

5. **REC Button**

Press this button to force manual recording. To stop manual recording, press it again.

6. **Play/Pause Button (▶/||)**

Press this button to play the recorded images, or pause the playback.

7. **Stop (■) Button**

Press this button to stop the playback.

8. Copy() Button

Press this button to copy the playback images to the storage device connected to the USB port. Press this button again to stop copying.

9. MENU / ESC Button

Press this button to display the main menu or escape to the upper level display. [At playback, press this button for the snapshot of the playback video.](#)

10. Up/BS Button (▲/BS)

Press this button to move the cursor or focus window in most circumstances. In PTZ control, press this button to tilt up the camera. In text editing mode, this button is used as “backspace” key.

11. Down/DEL Button (▼/DEL)

Press this button to move the cursor or focus window in most circumstances. In PTZ control, press this button to tilt down the camera. In text editing mode, this button is used as “del” key. In playback mode, press this button for single step.

12. Left/Right Buttons (◀,▶)

In PTZ control, press these buttons to pan the camera. In playback mode, press these buttons for fast backward/forward. In the other screens, press these buttons to move the cursor or focus window.

13. ENTER Button

This button is used as “enter” key in most circumstances. In PTZ control, this button is used to start/stop the selected PTZ control mode.

14. (Split Windows) +/- Buttons ()

In split-window display, press these buttons for next/previous split-window display. In the others, press these buttons to change the contents.

15. DVR ID Selection Buttons (DVR #1-4)

Press these buttons to select the DVR to be controlled by the remote controller. The remote controller can control up to 4 sets of DVRs. **Please make sure that the DVR ID (in IR Setup) for each of the DVRs is set correctly.**

16. Alpha-numeric Buttons (1-9, 0, *, #)

Press these buttons for camera selection in most of the circumstances. These buttons can also be used to enter text and number in the way similar to most of the mobile phones.

17. Alarm Reset Button

Press this button to cancel alarm activation, and return the system to the condition before the alarm was activated.

18. MUTE/NEXT Button

In PTZ control, press this button for the next miscellaneous control. In the other screens, press this button to mute the audio.

19. X2/GOTO Button

In PTZ control, press this button to move the camera to the preset position. In full screen display, press this button for Digital Zoom (X2/X4).

20. (Vol/Zoom) +/- Buttons (+/- / )

In PTZ control, press these buttons to zoom in/out the camera.

3. Installations

The installations described below should be made by qualified service personnel or system installers.

3.1 Basic Connections

Please refer to the following diagram for the connections.

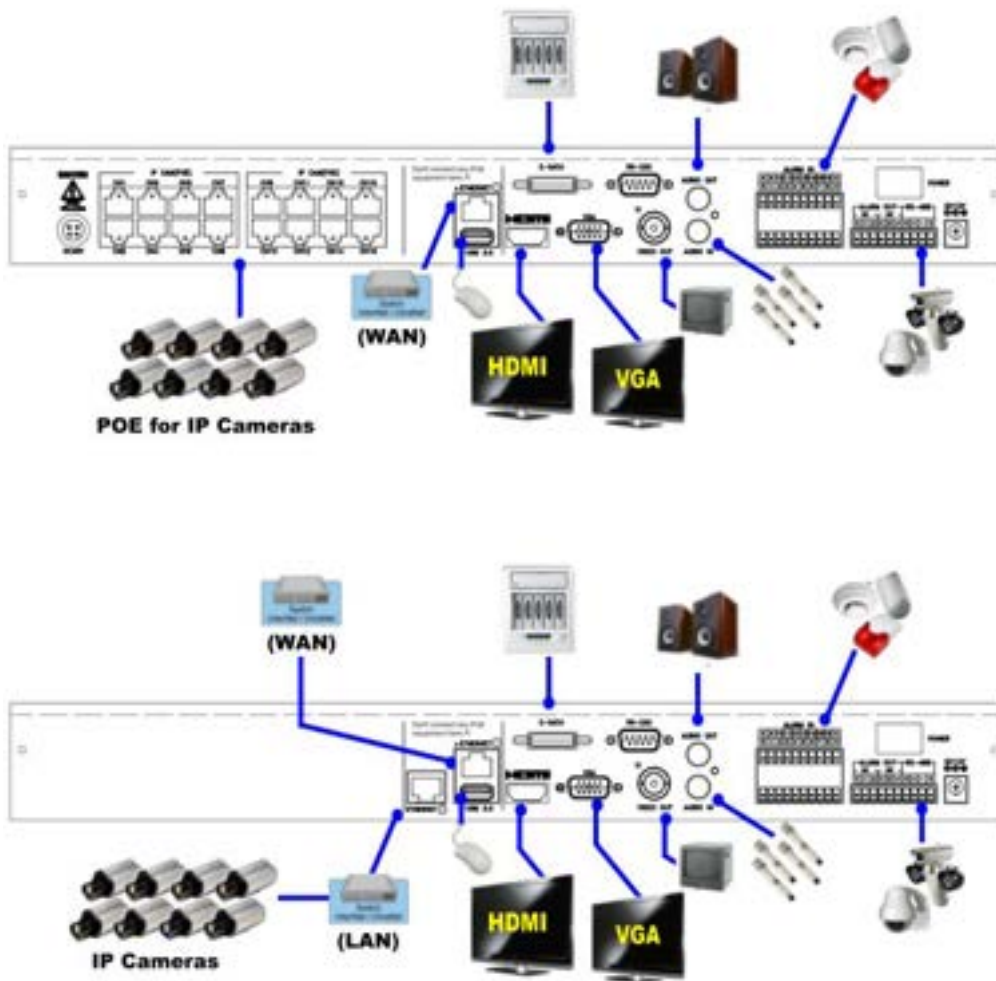

Please make sure to set the NTSC/PAL Selector Switch on the main board according to the local TV system for the system to work correctly.

- **Cameras**
PoE model: Connects the network camera to each Ethernet connector via the network cable to POE.
Non-PoE models: Connects the network camera to the Ethernet connector of the LAN via the network cable.
- **Main monitor**
Connect the main monitor output connector (BNC/VGA/HDMI) to a surveillance TV/VGA monitor. The TV/VGA monitor displays selected live or recorded cameras in any

available split window format.

- **Hard disk drive**

Make sure to install (at least) one SATA hard disk inside the DVR.

Note 1: **The HDD must be formatted before it can be used to record video/audio.**

Please refer to [Section 6.5.1](#) to format the HDD.

- **Power**

Connect the power source to **DC 12V**.

- **USB Port**

Connect Mouse or USB pen drive.

3.2 Optional Connections

■ Audio input

Connect the audio input connectors to the audio line-out from system cameras or other audio sources. Please make sure to associate the audio inputs with the cameras in Camera Setup as described in [Section 6.1](#) accordingly.

■ Audio output

Connect the audio output connector to the audio line-in from speakers.

■ Alarm input

Connect the alarm inputs to NC and/or NO type of alarm signals. Please make sure to setup the alarm configurations as described in [Section 6.2](#) accordingly.

■ Alarm output

Connect the alarm output #1 to NC type of alarm signal, or alarm output #2 to NO type of alarm signal.

■ Ethernet

Connect the Ethernet connector to a standard twisted-pair Ethernet cable for **IP CAM** and remote access via LAN or internet. Please make sure to setup the related configurations as described in [Section 5.5](#) and [Section 6.1](#).

■ USB 2.0 disk drives, card reader, etc.

If the user wants to use USB2.0 peripheral device to retrieve important recorded images and/or audio, please connect it to the USB2.0 port connector.

■ I/R remote controller

The user may use I/R remote controller to control the digital video/audio recorder.

■ Call monitor

Connect the call monitor output connector to a surveillance TV monitor. This monitor displays the full screen images of the cameras associated with the events (alarm or motion) or the images from the installed cameras sequentially according to the SEQ Display Setup ([Section 6.3](#)) for call monitor.

■ **PTZ Cameras**

Connect the RS-232 connector or the RS-485 connector to PTZ camera(s) via the appropriate cable. The system supports a variety of different PTZ cameras, including Pelco D protocol Dome, SamSung SCC-641P, Kalatel Cyber Dome, Bosch AutoDome, etc. But different PTZ cameras can coexist in a system only if they support the same protocol. Please make sure to set the PTZ ID of the camera(s), and setup the camera ([Section 6.1](#)), and RS-232 or RS-485 ([Section 6.8](#)) accordingly.

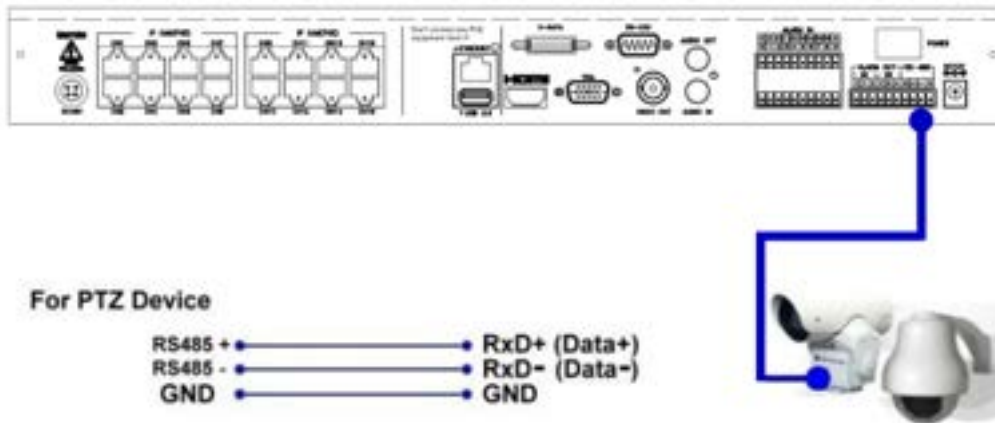

■ **eSATA Hard Disk**

Connect the eSATA connector to an eSATA hard disk for HDD extension.

■ **GPS modem**

Connect the RS-232 or RS-485 connector to GPS modem via the appropriate cable. The system supports the GPS modems with **NMEA0183** protocol. Please make sure to setup the RS-232 and RS-485 port ([Section 6.8](#)) accordingly.

■ **POS system**

Connect the RS-232 connector to POS system via the appropriate cable. The system supports the POS systems which can be connected to the following printers – Epson-TM200, Epson-TMU295, Epson-TMU300, Epson-TMU675, Epson-TMT882, Epson-RPU420, and Epson-MD332S. For 1-to-1 POS, please make sure to setup the RS-232 and RS-485 port correctly ([Section 6.8](#)). For Multiple POS, please make sure to setup the ID of protocol converter I-7524 correctly ([Appendix D](#)), and then setup the RS-232 and RS-485 port correctly ([Section 6.8](#)).

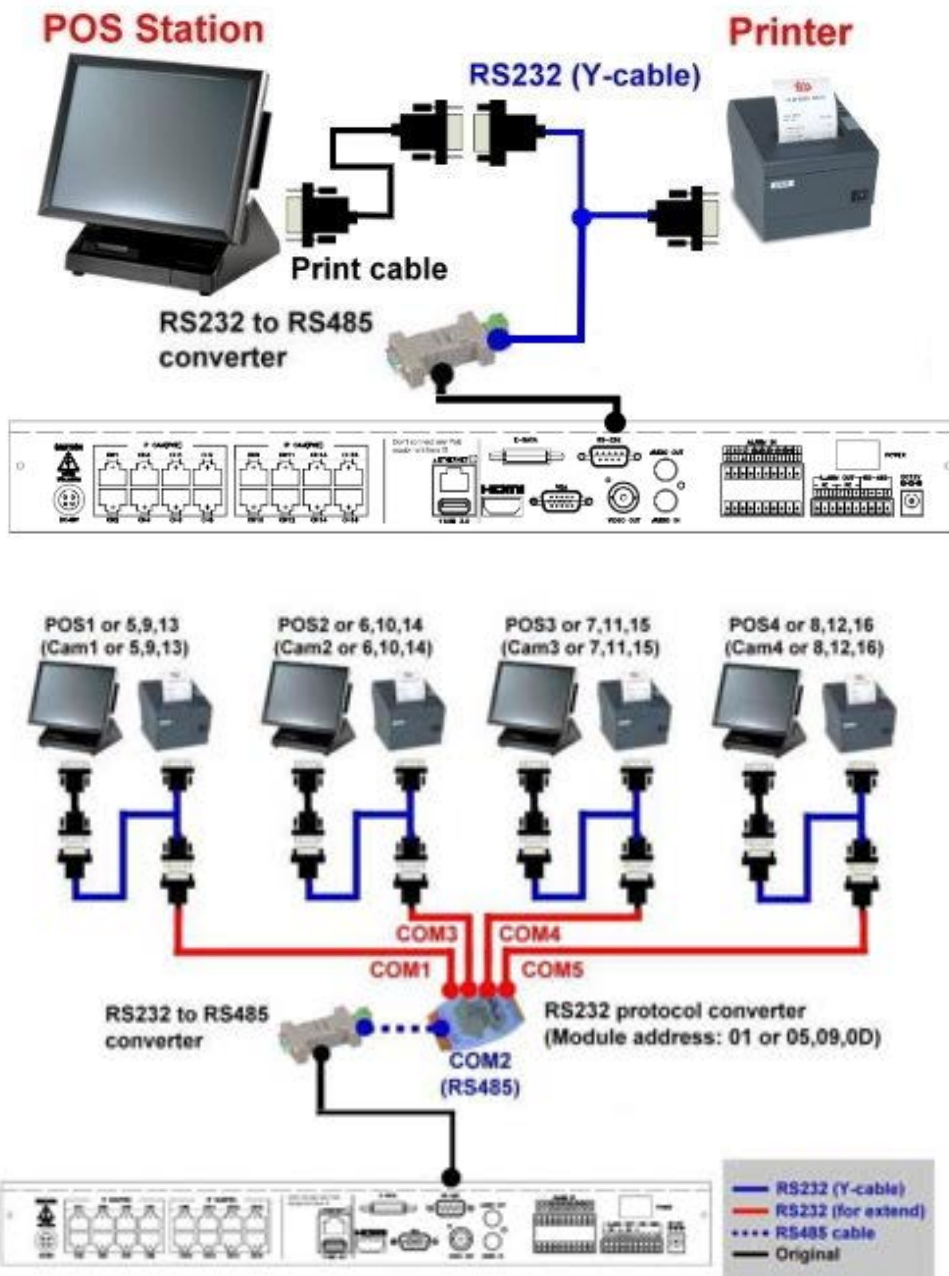

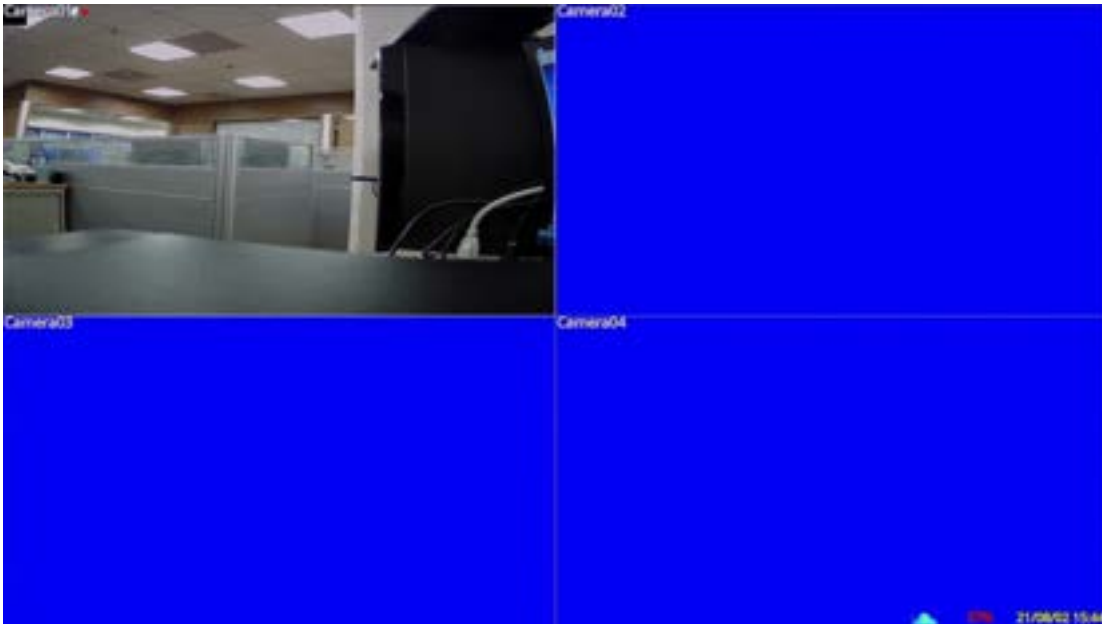

Top figure: 1-to-1; bottom figure: RS-232/Multiple, 1-to-many

4. Main Screen and Basic Operations



The split-window screen, as shown above, is the main screen after system startup. There are several types of split-window screens, including 1-Window, 4-Window, 7-Window, 9-Window, and 16-Window. The system will remember the last one before the normal shutdown (as described in [Section 5.7](#)) of the system. In addition to the split windows, the system time and the system states are displayed in the lower-right corner. The screen messages in the lower-left corner, shown while a certain event occurs.

The system states, from right to left, are described as the followings:

- (1) Normal recording percentage
- (2) Alarm recording percentage
- (3) Manual record ON/OFF –  shown for ON
- (4) Backup state – Backup status shown
- (5) Number of remote connections –  The number in the icon is the current number of connections.

* If the mouse is connected, the mouse operation icons will be shown when the mouse cursor is moved to the bottom of the screen.

* Recording icon, Motion, & Alarm for the camera may be shown after camera title.

4.1 Text Input

There are certain circumstances that the system requires the user to enter text, such as system login, camera title setup, and so on. To enter text, please left-click the mouse to edit the highlighted field. The flashing cursor will be shown to indicate the editing point, and the keyboard will be shown as below:



4.2 Login and Logout

There are three preset password levels in the system, including **Administrator** (highest), **Supervisor**, and **Operator** (lowest). Besides, the system also provides **Customized** password level. If the user does not login the system, he/she will be treated as “Guest” and can only view live video display.

The system allows up to 18 user accounts. The administrator can set up the login name and password for each user. (Please refer to [Section 6.6](#) for Password Setup.)

The Operator can operate live video display, the Supervisor live video display, image playback and archive, and the Administrator everything.

To Login/Logout system, right-click the mouse in split-window to call up Menu display then Left-click the mouse to select the **Login/Logout** In Menu display, the Login/Logout will be shown.

A screenshot of a dialog box titled "Login / Logout" with a close button (X) in the top right corner. The dialog box has two text input fields: "Login Name" with the text "aa" and "Password" with two asterisks "••". Below the fields are two buttons: "Login" and "Cancel".







In Login/Logout display, follow the Text Input method described in [Section 4.1](#) to enter the Login Name and Password, and select the Login/Logout option to log in/log out to the system.





There is one factory-preset login name/password aa/11 at the Administrator level. The user can use it to log in to the system for the first time.

Should the user have forgotten all the administrator-level passwords, please contact the local dealer or installer.

4.3 Basic Operations

The basic user's operations after he/she has logged into the system are described as below:

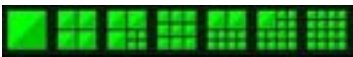
- **REC (Mouse: )**
Press this button to force manual recording. To stop manual recording, press it again.
All cameras will be recorded as if the scheduled record is A/V, and  will be shown on the lower-right corner of the screen if manual recording is ON.
- **Alarm Reset (Mouse: )**
Press this button to cancel alarm activation, i.e. reset the alarm outputs and silence the buzzer.
- **Vol+/-, MUTE (Mouse: )**
Total volume control. Includes real-time and playback.
- **X2 (Mouse: )**
In full screen display, press this button to enter Digital Zoom mode. Please refer to [Section 4.4 Digital Zoom](#) for the detailed operations in Digital Zoom mode.
- **SEQ (Mouse: )**
Press this button to switch to or return from SEQ display mode. In SEQ display mode, each page in the sequence will be shown for the preset page dwelling time sequentially.



When the SEQ starts/ends, the SEQ icon  /  will be displayed in the upper right corner of the screen for about three seconds.
-  (Mouse: )
Press these buttons to circulate up/down among the available split-window displays.
- **SEARCH (Mouse: ) (Administrator/Supervisor)**
In split-window display, press this button to display the search menus. The system will remember the last one the user chose.
- **Mouse Left click**
Select the focus window in the split-window display. The border color of the focus camera will change accordingly.

4.4 Digital Zoom



The system supports X2/X4 Digital Zoom function.

To use this function, press **Zoom** button (Mouse: ) in full screen display to enter Digital Zoom mode. There will be a zoom window shown in the video window as shown. The zoom window (a) will always be shown at zoom factor X1, (b) can be shown or hidden at zoom factor X2, and (c) will never be shown at zoom factor X4. The operations in Digital Zoom mode are as below:

- **▲▼◀▶ (Mouse: Click the video window)**
 - (a) **Click outside the yellow zone of the video window** to move the yellow zone zoom window if it's shown in the video window.
 - (b) **Click in the video window** to navigate the video window around if the zoom factor is X2 or X4.
- **ENTER (Mouse: Click in the video window)**
Click in the yellow zone of the video window to zoom in the zoom window, from X1 to X2 or from X2 to X4, if the zoom window is shown in the video window.
- **X2 (Mouse: )**
Press this button to
 - (a) Show/hide the zoom window if the current zoom factor is X1/X2.
 - (b) Zoom out the video window back to zoom factor X1 if the current zoom factor is X4.
- **ESC (Mouse:  or Right Click)**
Press this button to escape from X4 Digital Zoom mode, and return to the normal full-screen display.

5. Menu Display

Right-click the mouse in the split-window display to call up the **Menu** as shown below:



There are a variety of displays under Menu display. In the Menu display and all the subsequent displays, the items are disabled in the gray-out icon. Please refer to [Section 4.2](#) for Login/Logout display.

The user's operations are described as the followings:

- **ENTER (Mouse: Click in the menu item)**
Press this button to enter the detailed display of the highlighted option. For the details of each option, please refer to the following sections.
- **X (Mouse: Left Click X or Right Click to leave)**
Press this button to escape from Menu display, and return to split-window display.

5.1 Status Display

Left-click the mouse to select the **Status** (Mouse: ) In Menu display, the system status will be shown.

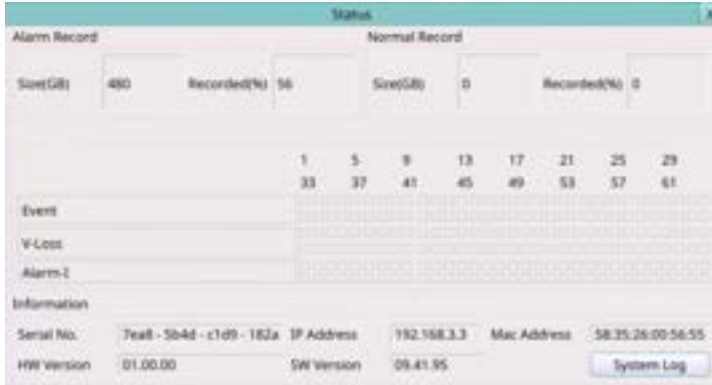

The status display includes Alarm Recording Status, Normal Recording Status, Camera Status, Alarm Input Status, Product Serial Number, Product Version Number, and IP Address. Press **X** (Mouse: **Left Click X or Right Click to leave**) to escape from the Status display, and return to Menu display.

- **System Log** – the system events are to be shown in the log list. It includes all system-related events, such as power on/off, and will not trigger recording.

5.2 Volume Control

Left-click the mouse to select the **Volume** (Mouse: ) In Menu display, the Volume Control will be shown.

The general operations are as below:

- **Mouse: Click in the respective item**
Select the items to set.
- **X (Mouse: Left Click X or Right Click to leave)**

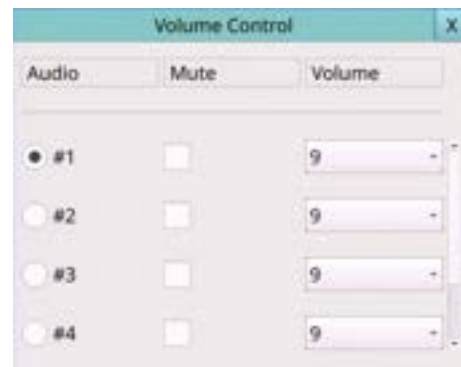

Press this button to escape from this screen, and return to Menu display. If the contents have been modified, a Save dialog will be shown to ask the user to save the changes, press **YES** to exit and save, **CANCER** to exit without saving.

Following is a brief description for each item and its specific operations:

- **Mute** – to mute the selected audio channel. The default setting is unchecked.
- **Volume** – the volume of the selected audio channel.

Note: If want to adjust the audio volume of IP Camera, please change the setting in IP Camera.

Note: The sound source of the volume control will be linked to the audio input setting of the [6.1 camera setup](#). For example, if the CH1 audio input is set to **N/A /1/Camera**, then #1 of the volume control will hear **no sound/1/with the sound from the IP camera**. The volume control only adjusts the volume from the Audio Input of the device.

5.3 Video Adjustment

Left-click the mouse to select the **Video Adjustment (Mouse: **) In Menu display, the Video Adjustment will be shown.



There are 4 items which can be adjusted, including Brightness, Contrast, Hue, and Saturation. The operations are as below:

- **Numeric (Mouse: Left-click the mouse to select the values)**
Press these values to adjust the selected items.
- **Factory Reset This (Mouse: Left-click the mouse to select this)**
Press this button to reset the settings for this camera to factory default values.
- **Factory Reset All (Mouse: Left-click the mouse to select this)**
Press this button to reset the settings for all cameras to factory default values.
- **Restore (Mouse: Left-click the mouse to select this)**
Press this button to restore the values.
- **X (Mouse: Left Click X or Right Click to leave)**
Press this button to escape from this screen, and return to Menu display. The settings will be saved for future reference.

5.4 Display

Left-click the mouse to select the **Display (Mouse: )** In Menu display, the Display Setup will be shown.

There are several items which can be adjusted, including Resolution, Brightness, Contrast, Hue, etc. Besides, Touch panel models are also supported. The operations are as below:



- **Numeric (Mouse: Click in the respective item)**

Press these values to adjust the selected items.

- **Factory Reset (Mouse: Left-click the mouse to select this)**

Press this button to restore the items above to factory default values.

- **X (Mouse: Left Click X or Right Click to leave)**

Press this button to escape from this screen. If the contents have been modified, a Save dialog will be shown, press **YES** to exit and save, **CANCER** to exit without saving. **Please note that the display may not be able to support the resolution newly selected, and hence the display will show nothing. If so, please press **CANCER** or wait for 15 seconds to restore the original resolution. If users press **YES** to accept the resolution change, the system will reboot. If the display shows nothing after reboot, please change the display setting via the remote side (Web side or HEM). After changed the display setting via the remote side, please reboot the DVR manually. If you don't know the IP address of the DVR, please use the "DVR Browser" to search the DVR information.**

5.5 Network

Left-click the mouse to select the **Network (Mouse: )** In Menu display, the Network Setup will be shown.



The Network Setup allows the administrator to setup all Ethernet network related parameters. Please check with your network administrator to set these parameters correctly.

The general operations are as below:

- **Mouse: Click in the respective item**

Select the items to set.

- **X (Mouse: Left Click X or Right Click to leave)**

Press this button to escape from this screen, and return to Setup Menu display. If the Save dialog is shown, press **YES** to exit and save, **CANCER** to exit without saving.

Following is a brief description for each item and its specific operations:

- **Net Type** – Static IP, PPPoE, or DHCP. **For internet access, please make sure the below IP Address is a public IP address; otherwise, (1) a router with public IP address is required, and the router must be setup for port mapping (forwarding) to the DVR, or (2) CMS server must be used (Sec. 5.5.4).**

- **P2P** – if enabled, the **QR code** of the DVR will be shown on the upper right corner, and users can scan it to access the DVR remotely through the QR code in the future. Please make sure that TCP hole punching is possible for the NAT, Full-cone or Address restricted cone, of the router connected to internet for the DVR or remote software.

- **IP Address** – Ethernet IP address of the “Net Type” above for the system. To get the static IP address, please contact your local ISP (Internet Service Provider). Please follow the Text Input method described in [Section 4.1](#) to modify these items.

- **Net Mask** – Net Mask for the Ethernet IP address. Please follow the Text Input method described in [Section 4.1](#) to modify these items.
- **Gateway** – Ethernet Gateway IP address. Please note that the priority of Gateway is (1) Ethernet Gateway and (2) 3G Gateway. Please follow the Text Input method described in [Section 4.1](#) to modify these items.
- **DNS** – DNS (Domain Name Server) IP address for Ethernet. Please follow the Text Input method described in [Section 4.1](#) to modify these items.
- **PPPoE Username** – PPPoE username for the system if PPPoE is used. Please follow the Text Input method described in [Section 4.1](#) to modify this item.
- **PPPoE Password** – PPPoE password for the system if PPPoE is used. Please follow the Text Input method described in [Section 4.1](#) to modify this item.
- **DDNS Type** – Dynamic, Static, Custom DDNS (Dynamic Domain Name Server) type, etc. Please contact your local DDNS Service Provider to get the DDNS URL, username, and password.
- **URL** – the URL (Uniform Resource Locators) for the system. Please follow the Text Input method described in [Section 4.1](#) to modify this item.
- **DDNS Username** – DDNS username for the DVR for Static IP, PPPoE, or DHCP. Please follow the Text Input method described in [Section 4.1](#) to modify this item.
- **DDNS Password** – DDNS password for the DVR for Static IP, PPPoE, or DHCP. Please follow the Text Input method described in [Section 4.1](#) to modify this item.

Note:

If DDNS Type is FreeDNS, the URL must be appended with “,hash”.

Click "Dynamic DNS" on the FreeDNS website (<http://freedns.afraid.org>), then click "Direct URL" to get the URL. **In the URL, the value after the ? is the "hash" value.**

The full URL that inputs to DVR is **the domain name that you set, hash**.

The full URL **must be less than 70 letters**.

- **Notification** – press **Notification (Mouse: Left click)** to call up Notification Setup. Please refer to [Section 5.5.1](#) for the details.
- **FTP** – press **FTP (Mouse: Left click)** to call up FTP Setup. Please refer to [Section 5.5.2](#) for the details.
- **4G/3G** – press **4G/3G (Mouse: Left click)** to call up 4G/3G Modem Setup. Please refer to [Section 5.5.3](#) for the details.
- **Advanced** – press **Advanced (Mouse: Left click)** to call up Advanced Network Setup. Please refer to [Section 5.5.4](#) for the details.
- **LAN** – press **LAN (Mouse: Left click)** to call up LAN Setup. Please refer to [Section 5.5.5](#) for the details.

5.5.1 Notification Setup

In Network Setup, press **Notification** to call up Notification Setup as shown.

The Notification Setup allows the administrator to set notification (email & push alarm) related parameters. When an event occurs and Notification/E-mail is enabled for the corresponding action, a notification will be sent based on the parameters set.

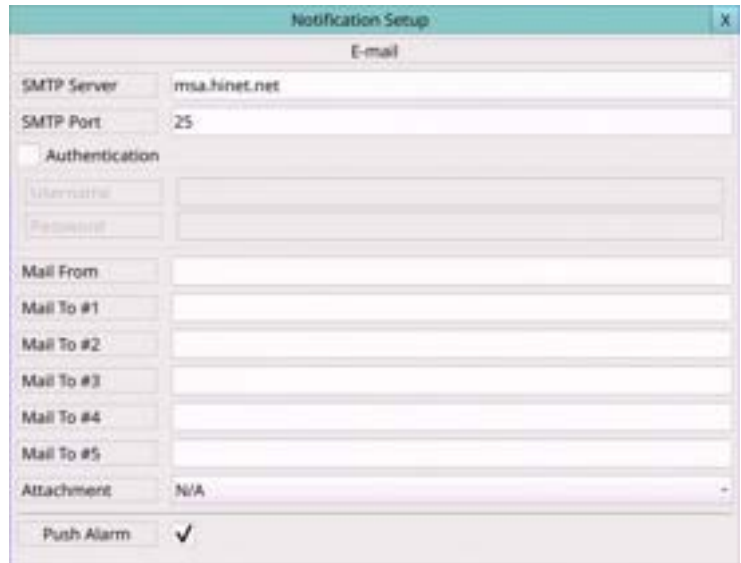

The screenshot shows a window titled "Notification Setup" with a sub-tab "E-mail". The fields are as follows:

SMTP Server	msa.hinet.net
SMTP Port	25
Authentication	
Username	
Password	
Mail From	
Mail To #1	
Mail To #2	
Mail To #3	
Mail To #4	
Mail To #5	
Attachment	N/A
Push Alarm	<input checked="" type="checkbox"/>

The general operations are as below:

- **Mouse: Click in the respective item**

Select the items to set.

- **X (Mouse: Left Click X or Right Click to leave)**

Press this button to escape from this screen, and return to Network Setup display. If the Save dialog is shown, press **YES** to exit and save, **CANCER** to exit without saving.

Following is a brief description for each item and its specific operations:

- **SMTP Server** – SMTP mail server name. Please follow the Text Input method described in [Section 4.1](#) to modify this item.
- **SMTP Port** – the SMTP port for e-mail transmission. The default value is **25**. Please follow the Text Input method described in [Section 4.1](#) to modify this item.
- **Authentication** – whether the SMTP mail server requires authentication.
- **Username** – username if the SMTP mail server requires authentication. Please follow the Text Input method described in [Section 4.1](#) to modify this item.
- **Password** – password if the SMTP mail server requires authentication. Please follow the Text Input method described in [Section 4.1](#) to modify this item.
- **Mail From** – the e-mail address of this DVR unit, i.e. the sender of the e-mails originated from the triggered events. Please follow the Text Input method described in [Section 4.1](#) to modify this item.
- **Mail To #1-5** – the receivers' e-mail addresses. The system can send the e-mails originated from the triggered events to up to 5 different receivers. Please follow the Text Input method described in [Section 4.1](#) to modify these items.
- **Attachment** – attached picture for the e-mail sent. The value could be (N/A, Original picture, QCIF picture).
- **Push Alarm** – whether Push Alarm is enabled for network notification.

5.5.2 FTP Setup

In Network Setup, press **FTP** to call up FTP Setup as shown.



Field	Value
FTP Server (URL or URL:Path)	192.168.1.253
FTP Port	21
Username	admin
Password	*****
Prefix Of Filename	

The FTP Setup allows the administrator to set FTP related parameters. When an event occurs and FTP is enabled for the action, the recorded video/audio for that event will be sent to the FTP server based on the parameters set here.

The general operations are as below:

- **Mouse: Click in the respective item**
Select the items to set.
- **X (Mouse: Left Click X or Right Click to leave)**
Press this button to escape from this screen, and return to Network Setup display. If the Save dialog is shown, press **YES** to exit and save, **CANCER** to exit without saving.

Following is a brief description for each item and its specific operations:

- **FTP Server** – **FTP server web/IP address with or without directory path.** Please follow the Text Input method described in [Section 4.1](#) to modify this item.
- **FTP Port** – the FTP port. The default value is **21**. Please follow the Text Input method described in [Section 4.1](#) to modify this item.
- **Username** – username for this DVR unit in the FTP server. Please follow the Text Input method described in [Section 4.1](#) to modify this item.
- **Password** – password for this DVR unit in the FTP server. Please follow the Text Input method described in [Section 4.1](#) to modify this item.
- **Prefix Of Filename** – the prefix of the filenames for the files sent to the FTP server. If it's empty, the filenames will be "cam."; if not, the filenames will be "Prefix-cam.". For example, if the prefix is "DVR01", then the filenames will be "DVR01-cam.". Please follow the Text Input method described in [Section 4.1](#) to modify this item.

5.5.3 5G/4G/3G Modem Setup

In Network Setup, press **5G/4G/3G** to call up 4G/3G Modem Setup as shown.

The 4G/3G Modem Setup allows the administrator to set 4G/3G modem related parameters if USB dongle 4G/3G modem is plugged in the USB port.

The general operations are as below:

- **Mouse: Click in the respective item**

Select the items to set.

- **X (Mouse: Left Click X or Right Click to leave)**

Press this button to escape from this screen, and return to Network Setup display. If the Save dialog is shown, press **YES** to exit and save, **CANCER** to exit without saving.

Following is a brief description for each item and its specific operations:

- **Username** – username if requested by ISP. Please follow the Text Input method described in [Section 4.1](#) to modify this item.
- **Password** – password if requested by ISP. Please follow the Text Input method described in [Section 4.1](#) to modify this item.
- **Dial String** – the 3G dial command. Please follow the Text Input method described in [Section 4.1](#) to modify this item.
- **APN** – (Optional) APN info. Please follow the Text Input method described in [Section 4.1](#) to modify this item.
- **PIN** – PIN associated with the SIM card used. Please follow the Text Input method described in [Section 4.1](#) to modify this item.
- **IP Address** – 3G IP address for the system. To get the static IP address, please contact your local ISP (Internet Service Provider). This field is for information only.
- **Net Mask** – Net Mask for the 4G/3G IP address. This field is for information only.
- **Gateway** – 4G/3G Gateway IP address. Please note that the priority of Gateway is (1) Ethernet Gateway and (2) 4G/3G Gateway. This field is for information only.
- **DNS** – DNS (Domain Name Server) IP address for the 4G/3G network. This field is for information only.

5.5.4 Advanced Network Setup

In Network Setup, press **Advanced** to call up Advanced Network Setup as shown.

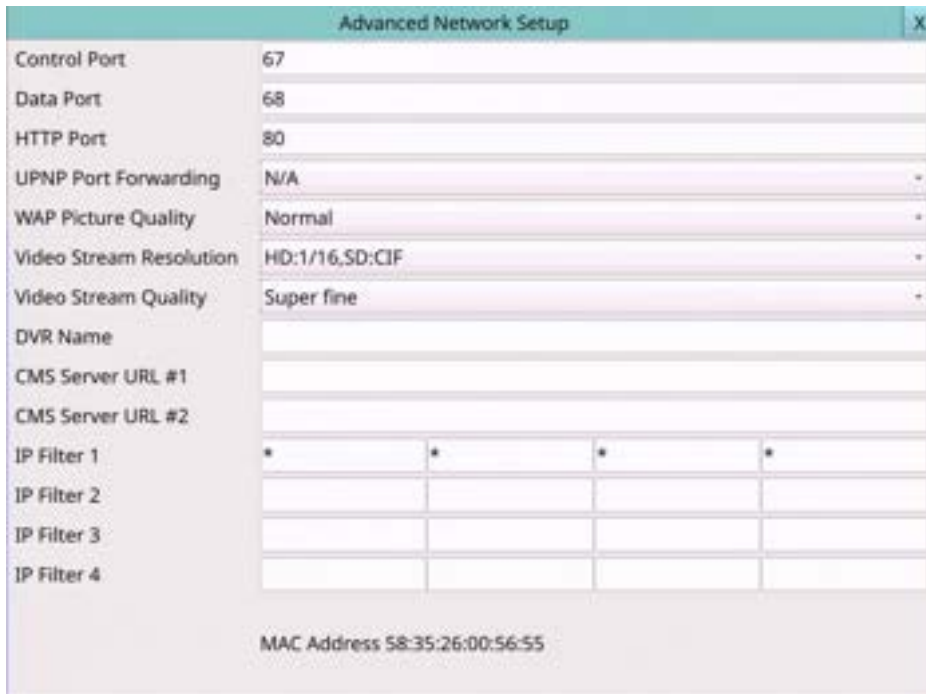

Advanced Network Setup	
Control Port	67
Data Port	68
HTTP Port	80
UPNP Port Forwarding	N/A
WAP Picture Quality	Normal
Video Stream Resolution	HD:1/16,SD:CIF
Video Stream Quality	Super fine
DVR Name	
CMS Server URL #1	
CMS Server URL #2	
IP Filter 1	* * * *
IP Filter 2	
IP Filter 3	
IP Filter 4	
MAC Address 58:35:26:00:56:55	

The Advanced Network Setup allows the administrator to set advanced network parameters. **If the user is not familiar with network administration, please DO NOT modify the items in this dialog.**

The general operations are as below:

- **Mouse: Click in the respective item**
Select the items to set.
- **X (Mouse: Left Click X or Right Click to leave)**
Press this button to escape from this screen, and return to Network Setup display. If the Save dialog is shown, press **YES** to exit and save, **CANCER** to exit without saving.

Following is a brief description for each item and its specific operations:

- **Control Port** – the control port for remote access. The default value is **67**. Please follow the Text Input method described in [Section 4.1](#) to modify this item.
- **Data Port** – the data port for remote access. The default value is **68**. Please follow the Text Input method described in [Section 4.1](#) to modify this item.
- **HTTP Port** – the HTTP (web page) port for remote access. The default value is **80**. **Please note that value 0 means to disable HTTP.**

- **UPnP Port Forwarding** – to use UPnP port forwarding for Control/Data/HTTP port for internet access if the router supports UPnP. If UPnP port forwarding is used, the DVR will try to connect with UPnP router to set Control/Data/HTTP port after the user exits from this screen. It may take from a few seconds to a few minutes. If successful, new Control/Data/HTTP port will be shown with (*) in front of it.
- **WAP Picture Quality** – the WAP picture quality if WAP access is supported for the DVR.
- **Video Stream Resolution** – network live video stream resolution.
- **Video Stream Quality** – network live video stream quality. Please note that the value cannot be changed due to the limitation of the main chip.
- **DVR Name** – the “DVR Name” used in the “CMS Server” if CMS Server (described below) is (to be) connected with the DVR. Please follow the Text Input method described in [Section 4.1](#) to modify this item.
- **CMS Server URL #1-2** – the URL (Uniform Resource Locators) for the CMS Server #1 and #2. The DVR will connect with up to two CMS servers automatically once it’s running. **Please note that with this feature, the DVR needs not to be a web server, while the CMS server needs to be a web server.** Please follow the Text Input method described in [Section 4.1](#) to modify these items.
- **IP Filter #1-4** – the IP filters #1-4 for remote access. Only those PCs with IP addresses matching one of the IP filters can access the DVR remotely. Please follow the Text Input method described in [Section 4.1](#) to modify these items.

Note: If the Control Port or Data Port is not available or accessible during remote access, the system will reset the ports to their default values, i.e. 67/68.

5.5.5 LAN Setup

In Network Setup, press **LAN** to call up LAN Setup as shown.

LAN Setup				
Net Type	Static IP			
Static IP				
IP Address	192	168	2	100
Net Mask	255	255	255	0
DHCP Server	Off			
Range				
Start IP Address	192	168	2	1
End IP Address	192	168	2	99

The LAN Setup allows the administrator to set **LAN (Second network port or network with optional POE)** related parameters.

The general operations are as below:

- **Mouse: Click in the respective item**

Select the items to set.

- **X (Mouse: Left Click X or Right Click to leave)**

Press this button to escape from this screen, and return to Network Setup display. If the Save dialog is shown, press **YES** to exit and save, **CANCER** to exit without saving.

Following is a brief description for each item and its specific operations:

- **Net Type** – Static IP or DHCP. It can set how to get the local IP address of the second network port. .

- **IP Address** – Ethernet IP address of the “Net Type” above for the system. Please follow the Text Input method described in [Section 4.1](#) to modify these items.

Note: The second network port or the local POE, whether it is to set static IP or DHCP, must be staggered from the network segment of the current network environment, and it also cannot be the same as the first network port.

- **Net Mask** – Net Mask for the Ethernet IP address. Please follow the Text Input method described in [Section 4.1](#) to modify these items.

- **DHCP Server** – To On / Off the built-in DHCP server in the device. If enabled, all devices connected to the second network port or IP cameras on the local POE can use the local built-in DHCP server.



Note: There can only be one DHCP server on the LAN.

- **Start IP Address** – The start of a range of IP addresses that the built-in DHCP server can use. Please follow the Text Input method described in [Section 4.1](#) to modify these items.

- **End IP Address** –The end of a range of IP addresses that the built-in DHCP server can use. Please follow the Text Input method described in [Section 4.1](#) to modify these items.





5.6. PTZ Control

The digital video/audio recorder supports a variety of PTZ cameras. The user can easily control the PTZ cameras through the operations described in this Chapter if those PTZ cameras have been connected and setup correctly. Please refer to [Section 3.2](#) Optional Connections for the connections. Please refer to [Section 6.1](#) Camera Setup to set the PTZ ID of each PTZ camera, and [Section 6.8](#) RS-232/485 Setup to setup the control port.

If the camera is also a PTZ camera, a PTZ icon () will appear after the title in the video window. Please left-click the mouse to select the **PTZ (Mouse: )** in the Menu display. If the focus camera is a PTZ camera, it can enter PTZ control mode.

In PTZ control mode, the user's operations can be divided into general operations and miscellaneous function-specific operations, and are described as the followings:

General operations:

- **X (Mouse: Left Click X or Right Click to leave)**
Press this button to exit PTZ control mode.
- **Menu (Mouse: Left-click the button)**
Press this button to Open UTC control menu of the camera.
-   **(Mouse: Left-click the button)**
Press these buttons to tilt the camera up/down.
-   **(Mouse: Left-click the button)**
Press these buttons to pan the camera left/right.
- **Zoom +/- (Mouse: Left-click the button)**
Press these buttons to zoom in/out the camera.
- **Goto (Mouse: Left-click the button)**
Press this button to move the camera to the preset position. Press numeric buttons **0-9** to enter the number of the preset position to move the camera to. **The range of the preset positions is 00-254.**

Miscellaneous function specific operations:

Active function	Operations	Descriptions
Focus	+/- Auto	focus far/near auto focus
Iris	+/-	Iris increase/decrease
Auto Pan	Select Value Run/ Stop Set Start Set Stop	Auto pan speed is shown in the center increase/decrease speed start/stop Auto Pan set start position set end position
Sequence	Select Value Run/ Stop	SEQ dwell time is shown in the center. If SEQ mode is on, the camera will go to preset position 0-9 (or 1-10) sequentially. change dwell time start/stop SEQ mode
Preset	Select Value Set Clear	Preset location is shown in the right lower corner change Preset location set Preset location clear Preset location
Pan Speed	Select Value	Manual pan speed is shown in parenthesis increase/decrease speed

5.7 System Shutdown (Administrator)

Left-click the mouse to select the **Shutdown** (Mouse: ) In Menu display to shut down the system. A confirmation dialog will be shown on the screen. Press **YES** to confirm the shutdown. The system will save all the files and all the states, and then display a power-off message in the left lower corner area of the screen. The user may power off the system safely when the power-off message is shown.



6. Setup (Administrator)

Left-click the mouse to select the **Setup** (Mouse: ) In Menu display, the Setup Menu will be shown. (To enter Setup Menu display of the system, please login as Administrator first.)



The user's operations are described as the followings:

The general operations are as below:

- **Mouse: Left Click in the respective item**

Select the items to set.

- **X (Mouse: Left Click X or Right Click to leave)**

Press this button to escape from this screen, and return to Menu display. If the contents have been modified, a Save dialog will be shown to ask the user to save the changes, press **YES** to exit and save, **CANCER** to exit without saving.

6.1 Camera Setup

Left-click the mouse to select the **Camera** (Mouse: ) In Setup Menu display, the Camera Setup will be shown.

There are IP CAM and analog cameras, can be connected. The Camera Setup allows the administrator to define some fundamental attributes for all the installed cameras.

The general operations are as below:

- **Mouse: Click in the respective item**

Select the items to set.

- **X (Mouse: Left Click X or Right Click to leave)**

Press this button to escape from this screen, and return to Setup Menu display. If the contents have been modified, a Save dialog will be shown to ask the user to save the changes, press **YES** to exit and save, **CANCER** to exit without saving.

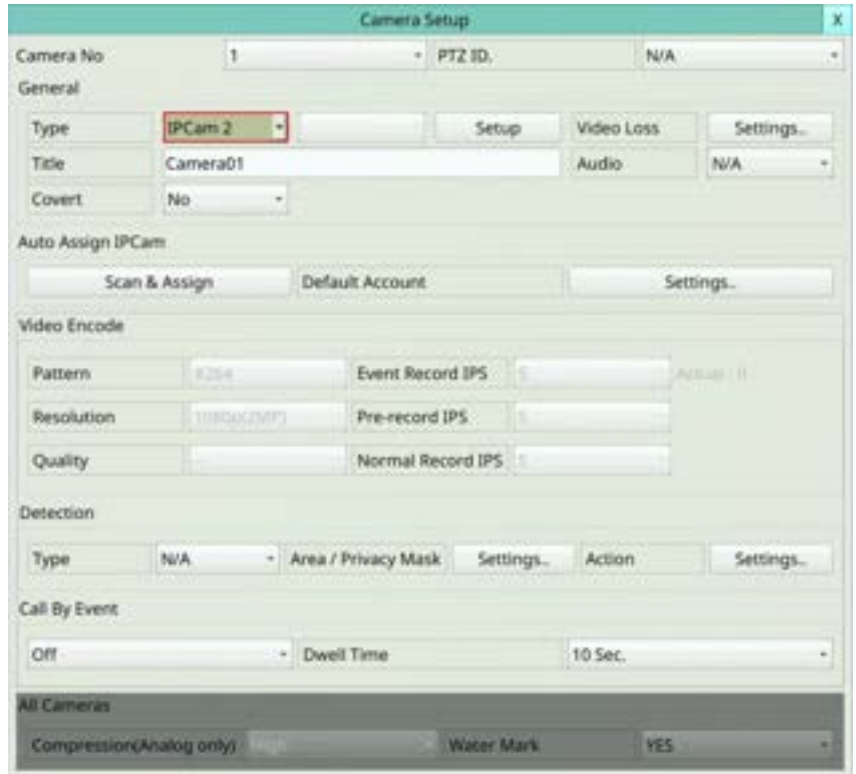

Following is a brief description for each item and its specific operations:

- **Camera No** – Press the **Numeric** to select the camera.
- **PTZ ID** – the PTZ ID of this camera if it's a PTZ camera. The PTZ ID has to be consistent with the setting of this camera. Please refer to the manual of the camera for the ID setting. Change the value (**N/A**, **0-255** for RS-485, or **non-485** for IP-CAM or **data-over-coax**). The default setting is "**N/A**" – Not Available, which means that it's not a PTZ camera.

All Cameras:

- **Compression (Analog only)** – Compression ratio of Normal or High. High compression ratio will result in smaller storage size, and hence longer recording time; but the Normal Record IPS will always be the same as Event Record IPS in Camera Setup, and Dual Streaming will always be used for network video. (This option is not available for IP camera.)
- **Watermark** – to record with digital watermark or not. If yes, all the recorded images for all the cameras will have digital watermark embedded.

Note: For the record data with the digital watermark, if the data is falsified, no matter whether the file is played locally or remotely when it is played to the time of the tampering, a warning message will pop up "File is corrupted or falsified. Do you want to continue? ".

General:

- **Type** – whether this camera is IP CAM or N/A. If IP CAM, the IP CAM settings will be settable.
- **Setup** – when Type set as IPCAM, it is used to set up the IPCAM related settings for this camera. Press Setup (Mouse: Left click) to call up the IPCAM Setup display for the camera as shown below.

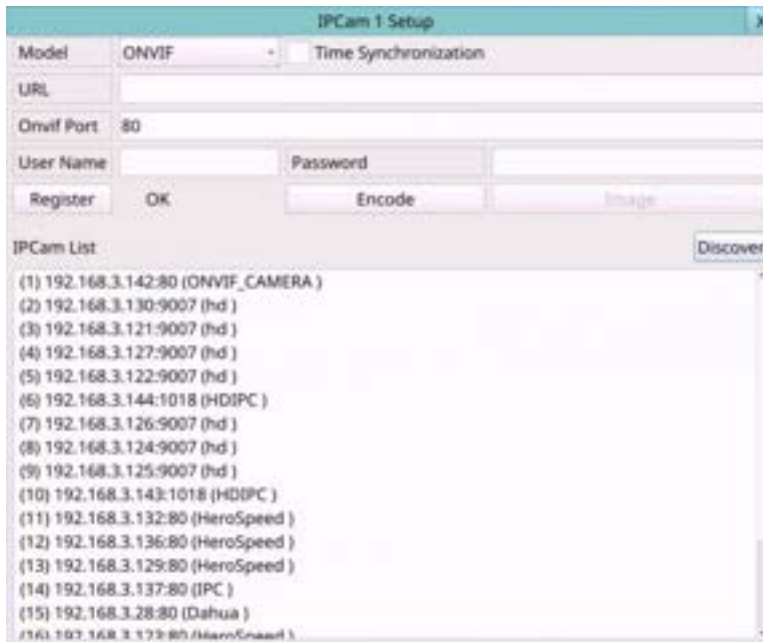

Please select **ONVIF** for the IP CAM that can support **ONVIF Profile S /Profile T**, otherwise select **RTSP**. For **ONVIF**, user can click on **Discover** to discover the IP CAM (static IP or DHCP) in the LAN, then **double click the left mouse button** to select the IP CAM in IPCAM List, the **URL** and **ONVIF Port** will be display in the field. For **RTSP**, please enter **Main Stream URI** and **Dual Stream URI** manually. Please also enter the correct Username, Password, and if it's to be time-synchronized with the NVR for the IP CAM. **Please note that camera setup is not supported for RTSP. However, live/network view, record, and playback are supported, but users need to configure the bit rate and the frame rate of main/dual stream manually so that the Max. Incoming bandwidth won't be exceeded.** For plug-and-play, please note that it is supported for DHCP or static IP of IP-CAM, but only two predefined sets of username/password for IP-CAM is supported.

After defined sets of Mode/ URL/ Onvif Port/ Username/ Password/ Time Synchronization, press **Register** to connect to the IP Camera.

Note: Add IP CAM via **left mouse button double click** from Discover IP CAM List, it would keep IP CAM's UUID. So that even if the IP URL changed, still can find the IP CAM and automatic use. If key-in the URL and ONVIF Port values directly, it wouldn't keep the UUID. After the IP CAM URL is changed, the user needs to modify the URL value manually.

- **Title** – The title (**Max. 16 characters**) of this camera. Please follow the Text Input method described in [Section 4.1](#) to modify this item.
- **Covert** – covert or not. If the camera is covert, the video of this camera can only be seen if the user has logged in as Administrator.

- **Video Loss** – used to setup the action settings when video loss is detected for this camera. Press **Settings (Mouse: Left click)** to call up Video Loss Setup display for the camera. Please refer to [Section 6.1.3](#) for the details.
- **Audio** – the AUDIO IN corresponding to this camera. The audio data for the selected AUDIO IN will be recorded with the video data for this camera. Select none (N/A) or AUDIO Inputs (1-4) or “**Camera**” that means audio from **IP-CAM**. The default setting is “N/A”.

Video Encode:

- **Pattern** – The Compression format for IP camera, please refer to [Section 6.1.1](#) for the details.
- **Resolution** – The Resolution for IP camera, please refer to [Section 6.1.1](#) for the details.
- **Record Quality** – The record quality for IP camera, please refer to [Section 6.1.1](#) for the details.
- **Event Record IPS** – the IPS (Images Per Second) for camera if certain event (Motion, Alarm) occurs for this camera. This camera will be recorded at this rate for Post-record time since the event occurs. For this NVR, Normal Record IPS are always the same as Event Record IPS and Pre-record IPS.
- **Pre-record IPS** – the pre-record IPS for camera if certain event (Video Loss, Motion, Alarm) occurs for this camera. This camera is recorded at this rate for Pre-record time before the event occurs. For this NVR, Normal Record IPS are always the same as Event Record IPS and Pre-record IPS.
- **Normal Record IPS** – the normal record IPS for camera. This camera will be recorded at this rate if no event occurs. For this NVR, Normal Record IPS are always the same as Event Record IPS and Pre-record IPS. **The Normal Record IPS for IP camera, please refer to [Section 6.1.1](#) for the details.**
- **Actual Event Record IPS** – the actual event record IPS set to the cameras because of the limitation of the total system performance.

Detection:

- **Type** – “N/A” or “Motion” to enable motion detection of this camera. **(Note: this field has no effect for the Smart Search information.)**
- **Area/Privacy Mask** – The settings are for motion detection and privacy mask settings. Please refer to [Section 6.1.4](#) for the details.
- **Action** – used to set up the Motion settings for Motion Detection. Press **Action (Mouse: Left click)** to call up the Detection Action Setup display for the camera. Please refer to [Section 6.1.4](#) for the details.

Call By Event:

- **Call By Event** – whether to switch the monitor to the video of this camera if certain event occurs for this camera. There are 4 options, including Off, Camera Event, Alarm, Both (Camera Event & Alarm).
- **Dwell Time** – the dwell time if **Call By Event** is set to Camera Event, Alarm, or Both.

6.1.1 IPCam Encode Setup

In IPCam Setup, press **Encode** to call up **IPCam Encode Setup** of the selected camera. The IPCam Encode Setup allows the administrator to define the encoding settings for the camera.



The general operations are as below:

- **Mouse: Click in the respective item**

Select the items to set.

- **X (Mouse: Left Click X or Right Click to leave)**

Press this button to escape from this screen, and return to IPCam Setup Menu display. If the contents have been modified, a Save dialog will be shown to ask the user to save the changes, press **YES** to exit and save, **CANCER** to exit without saving.

Following is a brief description for each item and its specific operations (**Mouse: Left click**) to change the settings:

- **Stream** –It is divided into main stream and sub stream. Main stream settings are used for video recording. Sub stream settings are used for live multi-views.
- **Profile name** –The profile name that main stream/ sub stream use.
- **Standard** – Compression format, H.265 or H.264.
- **Resolution** – Encoding resolution of IP Camera.
- **Frame rate** –Encoding frame rate of IP Camera.
- **Bitrate (kbps)** –Encoding bitrate of IP Camera.
- **Quality** –Encoding quality of IP Camera.
- **Gop length (fps)** –Encoding GOV length of IP Camera.
- **Apply** – Apply settings to IP Camera.
- **Refresh** – Reload the encoding settings of IP Camera.

6.1.2 IPCam Image Setup

In IPCam Setup, press **Image** to call up **IPCam Image Setup** of the selected camera. It will link to Video Adjustment, Please refer to [Section 5.3](#) for the details.

6.1.3 Video Loss Setup

In Camera Setup, press **Video loss settings..** to call up Video Loss Setup of the selected camera to set up. The Video Loss Setup allows the administrator to define how the system responds to the detected video loss for the camera.

The general operations are as below:

- **Mouse: Click in the respective item**
Select the items to set.
- **X (Mouse: Left Click X or Right Click to leave)**

Press this button to escape from this screen, and return to Camera Setup display. If the contents have been modified, a Save dialog will be shown to ask the user to save the changes, press **YES** to exit and save, **CANCER** to exit without saving.

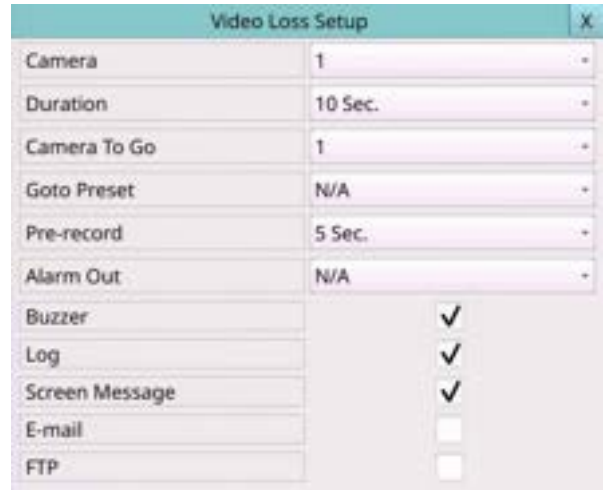

Video Loss Setup	
Camera	1
Duration	10 Sec.
Camera To Go	1
Goto Preset	N/A
Pre-record	5 Sec.
Alarm Out	N/A
Buzzer	<input checked="" type="checkbox"/>
Log	<input checked="" type="checkbox"/>
Screen Message	<input checked="" type="checkbox"/>
E-mail	<input type="checkbox"/>
FTP	<input type="checkbox"/>

Following is a brief description for each item and its specific operations:

- **Camera** – Press the **Numeric** to select the camera.
- **Duration** – response duration to define at most how long (in seconds) the Alarm Out relay and the Buzzer will keep being triggered after video loss is detected for this camera. However, the Alarm Out relay and the Buzzer will be reset immediately once the camera returns to normal. The value (3 seconds - 60 minutes, discrete, ‘-’ for ‘Forever’).
- **Camera to go** – the camera to go to the preset position in next field after video loss is detected for this camera. “Camera to go” camera must be a PTZ camera.
- **Goto Preset** – to define the preset position to go to for the “Camera to go” Camera in last field if video loss is detected for this camera. For more details about preset locations, please refer to [Section 5.6. PTZ Control](#).
- **Pre-record** – to define how long before video loss is detected this camera shall be intensively recorded at Pre-record IPS. Please note that the actual pre-record time may be shorter than the value set if the total size of the pre-record pictures exceeds the pre-record buffer size of the system.
- **Alarm Out** – to define which Alarm Output will be triggered when this event is triggered.
- **Buzzer** – to activate the internal Buzzer or not when video loss of this camera is detected.
- **Log** – to log to event logs or not.
- **Screen Message** – to display the event message on the screen or not.
- **E-mail** – to send the event e-mail to remote station or not. The e-mail will be sent to the predefined receivers at the moment when the event is triggered.
- **FTP** – to send the recorded event video/audio files to FTP server or not.

6.1.4 Motion/Privacy Mask Setup

In Camera Setup, press **Area/Privacy Mask** to call up Detection/Privacy Mask Setup as shown.

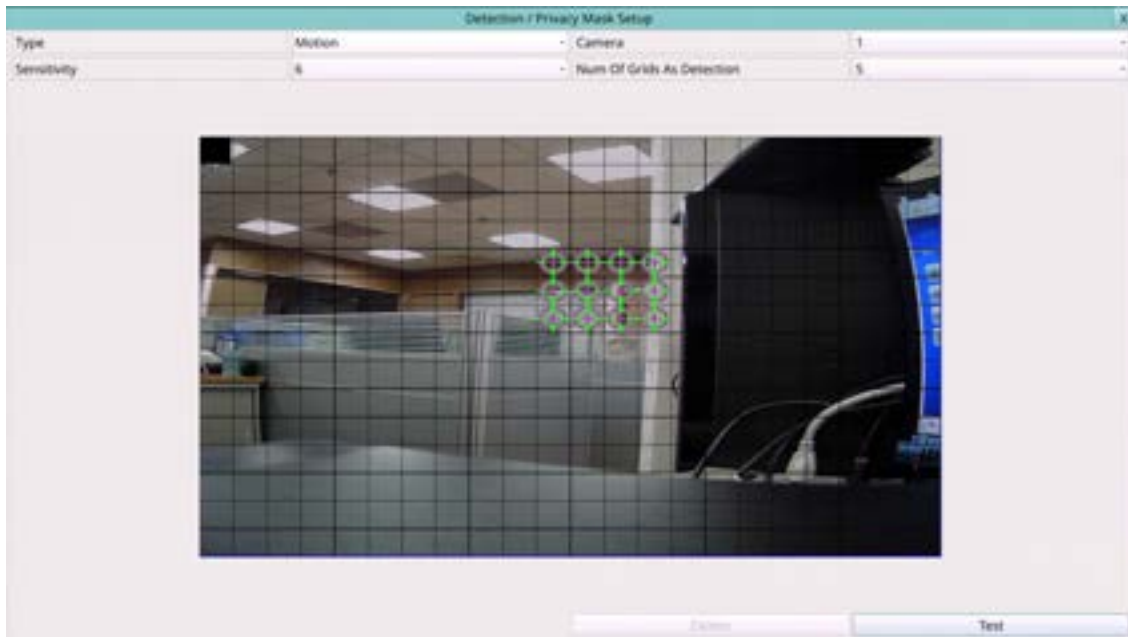

It used to setup the motion detection settings, including detection area and sensitivity, when motion is detected for this camera. Please note that the motion detection area and sensitivity are also used for the Smart Search information. There won't be any Smart Search information stored outside the detection area. So, it's better to enable the whole area if the motion detection for the camera is disabled (and only Smart Search is used). In Motion Detection Setup, the video area is divided into many small grids, and the area with  is the area which will be detected for motion, while transparent grids not detected for motion.

The general operations are as below:

- **Mouse: Click in the respective item**
Select the items to set.
- **X (Mouse: Left Click X or Right Click to leave)**
Press this button to escape from this screen, and return to Camera Setup display. If the contents have been modified, a Save dialog will be shown to ask the user to save the changes, press **YES** to exit and save, **CANCER** to exit without saving.

Following is a brief description for the operations of detection:

- **Type** – Press to select the type to set.
- **Camera** – Press the **Numeric** to select the camera.
- **Sensitivity** – The sensitivity, 1 – 10, for the motion detection of this camera.
- **Num Of Grids As Detection** – The “number of grids treated as motion”
- **Test** – Press this button to test the motion detection of this camera. The detected

motion will be shown on the screen. Press this button again to stop testing.

- **Privacy Mask Settings** – used to setup the privacy mask settings. The Privacy Mask Setup is similar to Motion Detection Setup, except that the green area of the camera will be blacked out for live/recorded video.

Following is a brief description for the operations of eFence detection (optional):

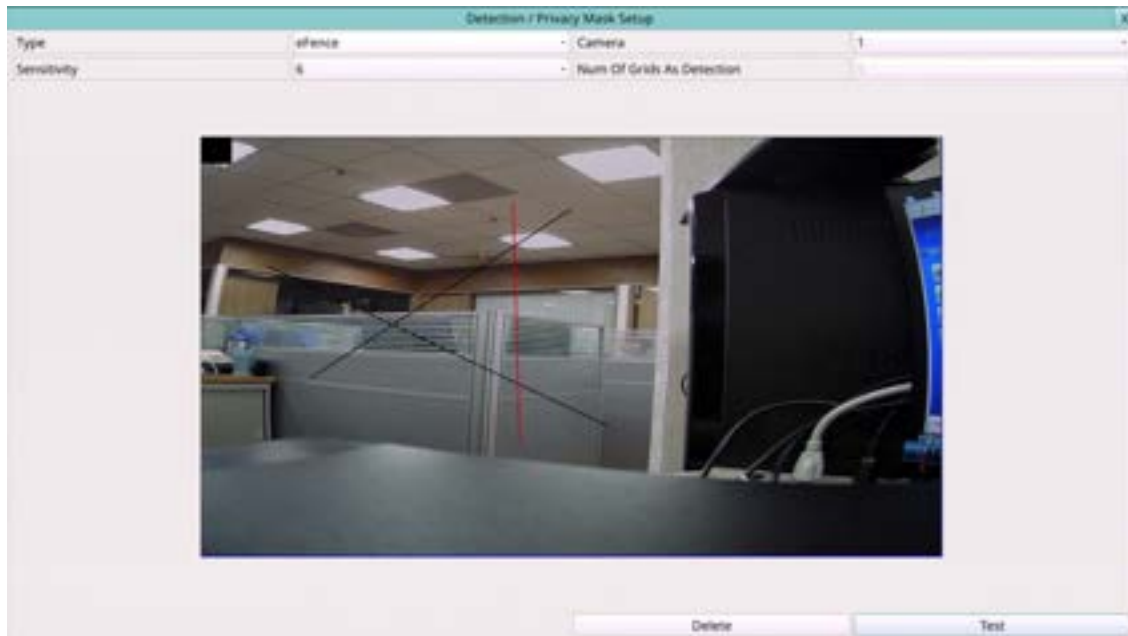

- **Type** – Press to select the type to set.
- **Camera** – Press the **Numeric** to select the camera.
- **Sensitivity** – The sensitivity, 1 – 10, for the motion detection of this camera.
- **Mouse: Left click and drag** – Draw the eFence line. Up to 4 lines can be drawn.
- **Mouse: Left click** – Click on the eFence line to select it.
- **Delete** – Click to delete the selected eFence line.
- **Test** – Click on this button to test. The color of the eFence line will be changed if it's crossed by an object of reasonable size. Click on it again to stop testing.
- **Privacy Mask Settings** – used to setup the privacy mask settings. The Privacy Mask Setup is similar to Motion Detection Setup, except that the green area of the camera will be blacked out for live/recorded video.

In Camera Setup, press **Action** to call up Detection Action Setup as shown.

Setting	Value	Setting	Value	Checkbox
Camera	1	Alarm Out	N/A	
Duration	10 Sec.	Buzzer		<input type="checkbox"/>
Camera To Go	1	Log		<input checked="" type="checkbox"/>
Go To Preset	N/A	Screen Message		<input checked="" type="checkbox"/>
Pre-record	5 Sec.	E-mail		<input type="checkbox"/>
Post-record	10 Sec.	FTP		<input type="checkbox"/>

It allows the administrator to define how the system responds to the detected motion for the camera.

Following is a brief description for each item and its specific operations:

- **Camera** – Press the **Numeric** to select the camera.
- **Duration** – response duration to define at most how long (in seconds) the Alarm Out relay and the Buzzer will keep being triggered after motion is detected for this camera. However, the Alarm Out relay and the Buzzer will be reset immediately once the camera returns to normal. The value (3 seconds - 60 minutes, discrete, '-' for 'Forever').
- **Camera to go** – the camera to go to the preset position in next field after motion is detected for this camera. "Camera to go" camera must be a PTZ camera.
- **Goto Preset** – to define the preset position to go to for the "Camera to go" Camera in last field if motion is detected for this camera. For more details about preset locations, please refer to [Section 5.6. PTZ Control](#).
- **Pre-record** – to define how long before motion is detected this camera shall be intensively recorded at Pre-record IPS. Please note that the actual pre-record time may be shorter than the value set if the total size of the pre-record pictures exceeds the pre-record buffer size of the system.
- **Post-record** – to define how long after motion is detected this camera shall be intensively recorded at Event Record IPS.
- **Alarm Out** – to define which Alarm Output will be triggered when this event is triggered. **Press to select Alarm Output Source.**
- **Buzzer** – to activate the internal Buzzer or not when motion of this camera is detected.
- **Log** – to log to event logs or not.
- **Screen Message** – to display the event message on the screen or not.
- **E-mail** – to send the event e-mail to remote station or not. The e-mail will be sent to the predefined receivers when the event is triggered.
- **FTP** – to send the recorded event video/audio files to FTP server or not.

6.2 Alarm Setup

Left-click the mouse to select the **Alarm** (Mouse: ) In Setup Menu display, the Alarm Setup will be shown. The Alarm Setup allows the administrator to define the attributes for each alarm input, and the actions if it's triggered. Up to 32 alarm inputs can be configured, which are directly connected to the system or the alarm inputs of IP-CAM.

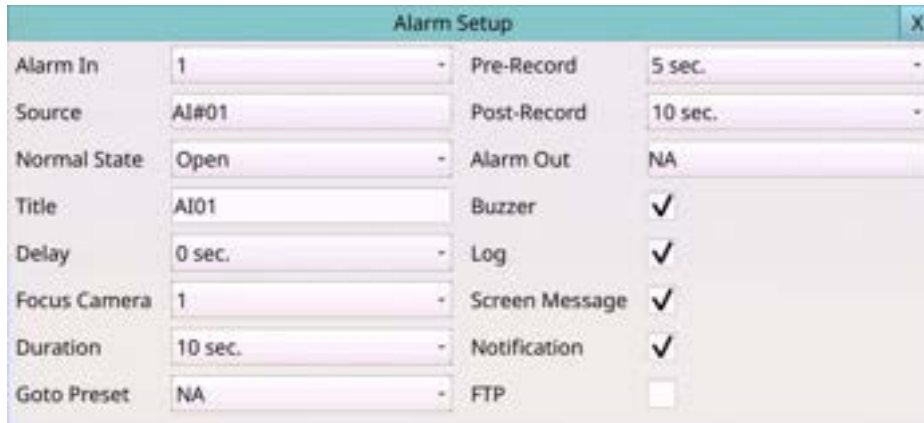

Field	Value	Field	Value
Alarm In	1	Pre-Record	5 sec.
Source	AI#01	Post-Record	10 sec.
Normal State	Open	Alarm Out	NA
Title	AI01	Buzzer	<input checked="" type="checkbox"/>
Delay	0 sec.	Log	<input checked="" type="checkbox"/>
Focus Camera	1	Screen Message	<input checked="" type="checkbox"/>
Duration	10 sec.	Notification	<input checked="" type="checkbox"/>
Goto Preset	NA	FTP	<input type="checkbox"/>

The general operations are as below:

- **Mouse: Click in the respective item**
Select the items to set.
- **X (Mouse: Left Click X or Right Click to leave)**
Press this button to escape from this screen, and return to Setup Menu display. If the contents have been modified, a Save dialog will be shown to ask the user to save the changes, press **YES** to exit and save, **CANCER** to exit without saving.

Following is a brief description for each item and its specific operations:

- **Alarm In** – Press the **Numeric** to select the Alarm In No.
The alarm in default is set as the Alarm In No1.
- **Source** – used to setup the Alarm Input Source, including **Source Type** which is **N/A**, **Local** or **IP-CAM**, **Source ID** which is **1-4/8/16** for **Local** or the **camera ID** for **IP-CAM**, and **Sub ID** which is **1-4** for **IP-CAM**.
- **Normal State** – **N/A**, **Close**, **Open**, **Close(Level)** or **Open(Level)**. Please check the signal type, normally close or normally open, connected to the alarm input terminal on the rear panel of the system. If there's no signal connected, please select **N/A** – Not Available, and the following items will not be settable. The default setting is **Open**. **Please note that for Close(Level) and Open(Level), the Duration and Post-record mentioned below will keep being activated when the alarm input is at alarm state.**
- **Title** – The title (Max. 8 characters) of this alarm input. Please follow the Text Input method described in [Section 4.1](#) to modify this item.
- **Delay** – the alarm input will be treated as if it's triggered Delay time (0-15 seconds) later after being really triggered, 0 sec. for no delay.

- **Focus Camera** – the camera corresponding to this alarm input.
- **Duration** – response duration to define at most how long (in seconds) the Alarm Out relay and the Buzzer will keep being triggered after this alarm input is triggered **or returns to normal**. The value '-' for 'Forever'.
- **Goto Preset** – to define the preset position to go to for the Focus Camera if this alarm input is triggered and the Focus Camera is a PTZ camera. For more details about preset locations, please refer to [Section 5.6. PTZ Control](#).
- **Pre-record** – to define how long before this alarm input is triggered the Focus Camera shall be intensively recorded at Pre-record IPS. Please note that the actual pre-record time may be shorter than the value set if the total size of the pre-record pictures exceeds the pre-record buffer size of the system.
- **Post-record** – to define how long after this alarm input is triggered **or returns to normal** the Focus Camera shall be intensively recorded at Event Record IPS.
- **Alarm Out** – to define which Alarm Output will be triggered when this alarm input is triggered. Alarm Output Source Setup up to 32 alarm outputs can be selected and the definitions are similar to alarm inputs.
- **Buzzer** – to activate the internal Buzzer or not when this alarm input is triggered.
- **Log** – to log to event logs or not.
- **Screen Message** – to display the event message on the screen or not.
- **Notification** – to notify mobile phones and/or send the event e-mail to remote station or not. The mobile phones with alarm notification from the DVR enabled will be notified, and the e-mail will be sent to the predefined receivers when the event is triggered.
- **FTP** – to send the recorded event video/audio files to FTP server or not.

6.3 Main/SEQ Display Setup

Left-click the mouse to select the **Main/SEQ Display** (Mouse: ) In Setup Menu display, the SEQ Display Setup will be shown.

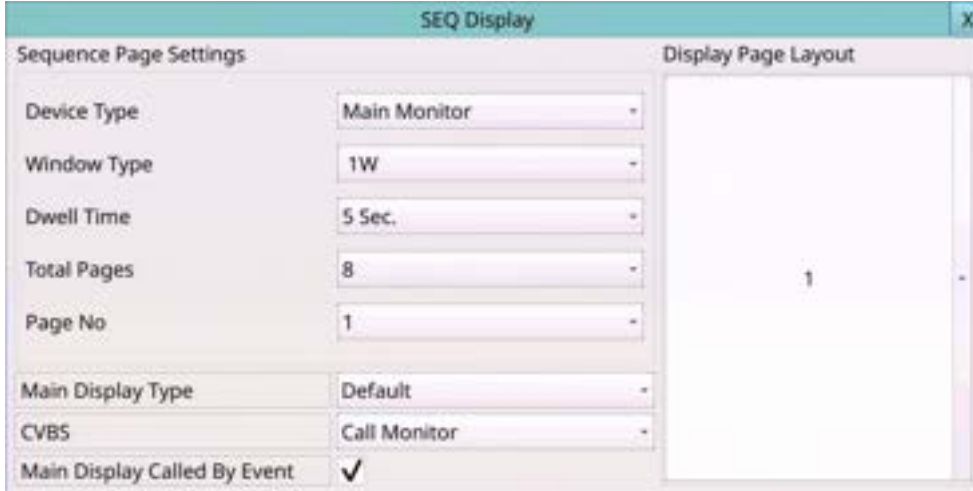

The Main/SEQ Display Setup allows the administrator to define the display pages in SEQ Display for main monitor and call monitor. **Please note that Call Monitor supports 1/4 split window display.**

The general operations are as below:

- **Mouse: Click in the respective item**
Select the items to set.
- **X (Mouse: Left Click X or Right Click to leave)**
Press this button to escape from this screen, and return to Setup Menu display. If the contents have been modified, a Save dialog will be shown to ask the user to save the changes, press **YES** to exit and save, **CANCER** to exit without saving.

Following is a brief description for each item and its specific operations:

- **Device Type** – select to set Main Monitor or Call Monitor.
- **Window Type** – select to set the split window.
- **Dwell Time** – the dwell time (3 ~ 60 seconds) for each page of this display type.
- **Total Pages** – total pages for this SEQ Display Type. The maximum number varies according to the display type.
- **Pages No** – to change the current page for this SEQ Display Type.
- **Display Page Layout** – used to set the camera in each viewing window for each page of this SEQ Display Type.

In Display Page Layout, the split window display for the current page is shown. Press ▼ buttons to change the camera for the current page.

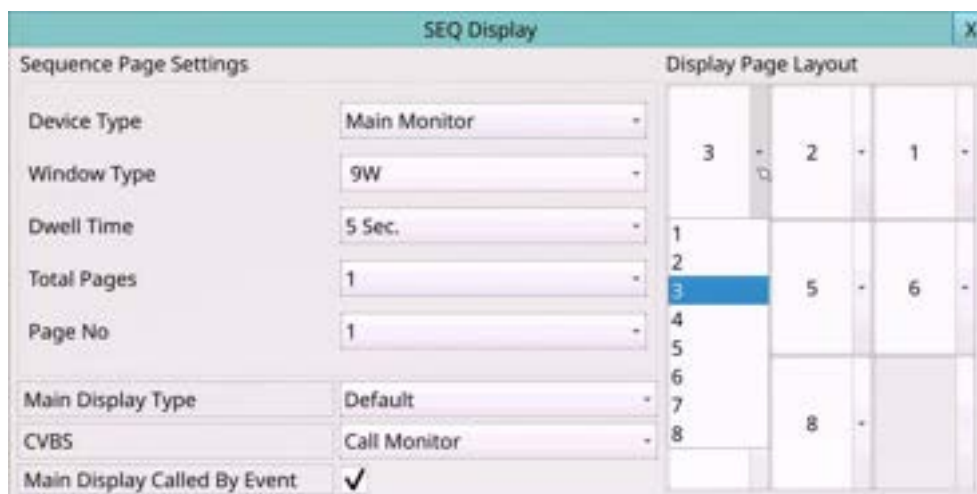

- **Main Display Type** – “Default” for default main display type and “SEQ” for main display to use SEQ settings.
- **CVBS** – CVBS out for “Main Monitor” or “Call Monitor”.
- **Main Display Called By Event** – to switch the main monitor to the video of the event camera or not.

Application of SEQ display settings - how to make different monitors see their respective channels.

We can set the **Main monitor** (HDMI/VGA) and the **Call monitor** (CVBS) to see the total number of pages and the camera channels under different window types.

For example, for a 16CH device, the main monitor can be limited to one page at 9W, CH1~CH9, and the call monitor can be limited to two pages at 4W, CH10~CH16. This allows different monitors to see their respective channels.

The main monitor display can also be controlled by **Covert** of camera setup [6.1](#) or Monitor Channel of **advanced user setup** in Password Setup [6.6](#).

6.4 Scheduled Record Setup

Left-click the mouse to select the **Schedule Record** (Mouse: ) In Setup Menu display, the Schedule Record Setup will be shown.

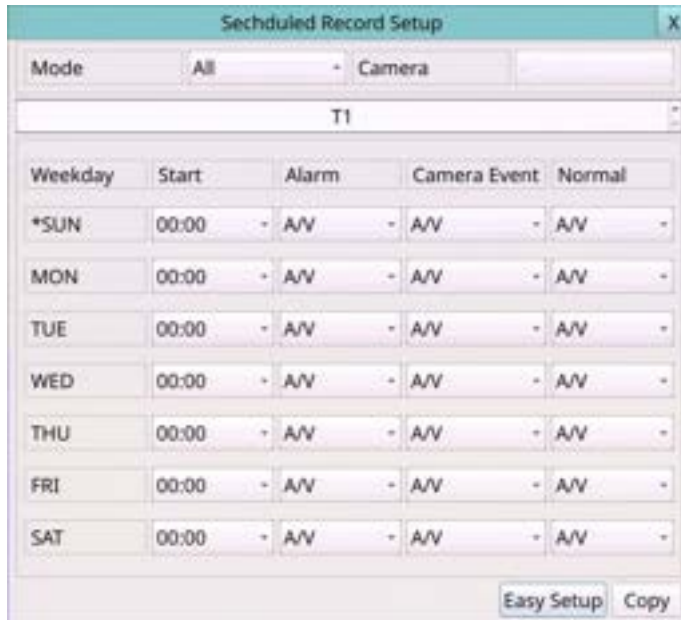

The Scheduled Record Setup allows the administrator to define when and how to record for the system. There are up to 16 time segments (T1 – T16) for each weekday.

The general operations are as below:

- **Mouse: Click in the respective item**

Select the items to set.

- **X (Mouse: Left Click X or Right Click to leave)**

Press this button to escape from this screen, and return to Setup Menu display. If the contents have been modified, a Save dialog will be shown to ask the user to save the changes, press **YES** to exit and save, **CANCER** to exit without saving.

- **COPY**

Press this button to copy the settings of (1) the focus camera to all the following cameras, or (2) the focus weekday to all the following weekdays. (EX. focus weekday is TUE, its settings will be copied to those of weekdays WED-SAT.)

To focus the weekday, click the week's text and there will be an asterisk (*) preceding its text.

- **Easy Setup (Mouse: Left click)**

Press this button to enter Easy Setup for Schedule Record as described in the following paragraphs.

Following is a brief description for each item and its specific operations:

- **Mode** – the schedule below applies to **All** cameras or **Individual** camera.

- **Camera** – select the camera if **Individual** is selected.

- **Start** – the start time of this time segment, increment at 30 minutes. (The end time of this time segment is implicitly set as the start time of next time segment, or the start time of the first time segment of the same weekday if it's the last one.)

Example: If the user sets the start time of T1/MON as 9:00, T2/MON as 18:00, T3-T16/MON as N/A (Not Available), then T1/MON is 9:00-18:00, T2/MON is 0:00-9:00, and 18:00-24:00.

- **Alarm** – record mode (No, Video, Audio/Video) when certain alarm input is triggered. **“OFF” is for alarm detection OFF.** Please note that the alarm is the alarm for the focus camera (in Alarm Setup) if **Individual** is selected.
- **Motion** – record mode (No, Video, or Audio/Video) when motion is detected for certain camera. **“OFF” is for motion detection OFF.**
- **Normal** – normal record mode, including No, V (Video only), or A/V (Audio/Video).

Note: In a time segment, if both Alarm and Motion are set to **“OFF”**, the audio/video will be treated as Normal unless there's Video Loss.

Scheduled Record – Easy Setup

The Scheduled Record – Easy Setup allows the administrator to use a simpler and easier way to setup the scheduled record of the system. In Easy Setup, there are **Six Selectable Recording Modes**: Alarm+Motion+Normal, Alarm+Motion, Alarm, Motion, Normal, and No Record. Video & Audio are all recorded for the selectable Recording Modes except **“No Record”**. After the Easy Setup, the time segments for each weekday in Scheduled Record will be updated accordingly.

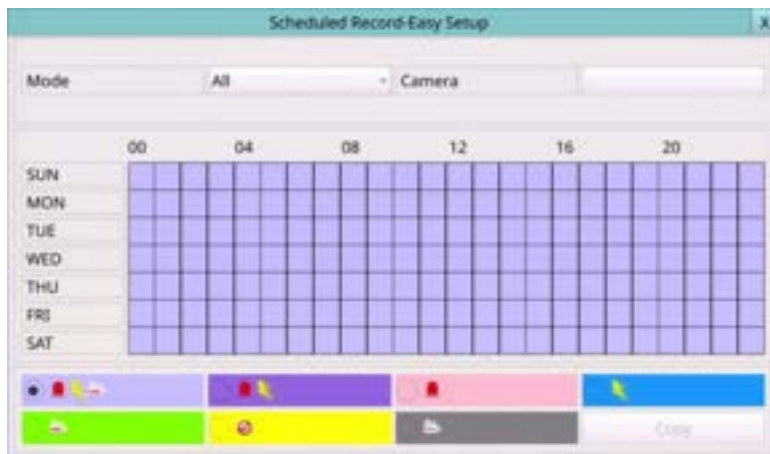

The operations are as below:

- **Mouse: Click in the respective item**
Select the items to set.
- **X (Mouse: Left Click X or Right Click to leave)**
Press this button to escape from this screen, and return to Scheduled Record Setup display. The time segments for each weekday in Scheduled Record will be updated accordingly. If the contents have been modified, a Save dialog will be shown to ask the user to save the changes, press **YES** to exit and save, **CANCER** to exit without saving.

■ **COPY**

Press this button to copy the settings of the focus camera to all the following cameras. (EX. focus camera is 2, its schedule settings will be copied to those of the cameras 3-8.)

■ **Color (Mouse: Left click)**

Press these buttons to select the active Recording Mode. The user may press the **different color radio button** when the focus is on the Recording Mode to activate it. The Recording Modes are : “Light purple color” – Alarm + Motion + Normal, “Dark purple color” – Alarm + Motion, “Light red color” – Alarm, “Blue color” – Motion, “Green color” – Normal, “Yellow color” – No Record, and Gray color for Others (which is not selectable).

■ **(Mouse: Left click and drag)**

Mouse left click and drag to set the focus interval (one grid for one hour) upwardly/downwardly to the different recording mode.

6.5 HDD Setup

Left-click the mouse to select the **HDD (Mouse: **) In Setup Menu display, the HDD Setup will be shown.



Record Type	Alarm Record	Normal Record
Size(GB)	480	0
Auto Overwrite	<input checked="" type="checkbox"/>	<input checked="" type="checkbox"/>
HDD Full Action	<input checked="" type="checkbox"/>	<input checked="" type="checkbox"/>
Duration	10 Sec.	10 Sec.
Alarm Out	N/A	N/A
Buzzer	<input checked="" type="checkbox"/>	<input checked="" type="checkbox"/>
Log	<input checked="" type="checkbox"/>	<input checked="" type="checkbox"/>
E-mail	<input type="checkbox"/>	<input type="checkbox"/>

HDD Format / Clear Advanced HDD Setup

In surveillance applications, alarm video/audio is much more important than normal video/audio. So, this digital video/audio recorder is designed to allow the user to divide each HDD into an alarm partition and a normal partition. And, alarm video/audio will be recorded in the alarm partition, normal video/audio in the normal partition.

The HDD Setup allows the administrator to format/clear each HDD, set the Alarm Record size and Normal Record size of each HDD, and define the behaviors for Alarm Record and Normal Record if it reaches the end of the last HDD in the system.

The general operations are as below:

- **Mouse: Click in the respective item**
Select the items to set.
- **X (Mouse: Left Click X or Right Click to leave)**
Press this button to escape from this screen, and return to Setup Menu display. If the contents have been modified, a Save dialog will be shown to ask the user to save the changes, press **YES** to exit and save, **CANCER** to exit without saving.
- **HDD Format/Clear (Mouse: Left click)**
Press this button to format/clear the HDDs as described in [Section 6.5.1](#).
- **Advanced HDD Setup (Mouse: Left click)**
Press this button to enter Advanced HDD Setup as described in [Section 6.5.2](#).

Following is a brief description for each item and its specific operations:

- **Size (GB)** – the total HDD storage in GB (Giga-Byte) for Alarm Record and Normal Record respectively. This item is just for information. Please refer to [Section 6.5.1](#) for more detailed information and the setup of each HDD. **Please note that if the total alarm record size is zero, the alarm video/audio will be recorded in the normal record partition. If the total normal record size is zero, the normal video/audio will be recorded in the alarm record partition.**
- **Auto Overwrite** – automatic overwrite of the recorded video/audio from HDD#1 when the Alarm/Normal Record disk drive capacity reaches the end of the last HDD. If Auto Overwrite is disabled and the Alarm/Normal Record disk drive capacity reaches the end, the system will not overwrite the recorded video/audio, and hence not record Alarm/Normal video/audio, until the user presses the **Alarm Reset** button.
- **HDD Full Action** – actions when Alarm/Normal Record disk drive capacity reaches the end of the last HDD.
- **Duration** – response duration to define at most how long (in seconds) the Alarm Out relay and the Buzzer will keep being triggered after the corresponding partition, Alarm Record or Normal Record, is full. The value - means forever.
- **Alarm Out** – to define which Alarm Output will be triggered when this event is triggered. Alarm Output Source Setup up to 32 alarm outputs can be selected and the definitions are similar to alarm inputs.
- **Buzzer** – to activate the internal Buzzer or not when the corresponding partition, Alarm Record or Normal Record, is full.
- **Log** – to log to event logs or not.
- **E-mail** – to send the event e-mail to remote station or not. The e-mail will be sent to the predefined receivers when the event is triggered.

6.5.1 HDD Format/Clear

In HDD Setup, press **HDD Format/Clear** to call up HDD Format/Clear Setup as shown.



The HDD must be formatted before it can be used to record video/audio. The HDD Format/Clear screen allows the administrator to format and/or clear each HDD, and set the size for Alarm Record partition and Normal Record partition for each HDD. **Please make sure there's no remote user before formatting the HDD.**

Please note that if NAS device is connected and setup correctly, it will be always the last storage in the HDD list.

The general operations are as below:

- **Mouse: Click in the respective item**

Select the items to set.

- **X (Mouse: Left Click X or Right Click to leave)**

Press this button to escape from this screen, and return to HDD Setup display. If the contents have been modified, a Save dialog will be shown to ask the user to save the changes, press **YES** to exit and save, **CANCEL** to exit without saving.

- **Format (Mouse: Left click)**

Press this button to format the HDD. A confirmation dialog will be shown on the screen. Press **YES** to confirm, or **CANCEL** to cancel. **Please note that it would take some time to format a brand new HDD.**

Note: If the HDD has not been formatted, it will be formatted and partitioned with default record size, **100% for Alarm and 0% for Normal**. If it has been formatted, it will be formatted according to the Alarm REC Size (%) and Normal REC Size (%) displayed on the screen, but the previously recorded contents within the new size won't be cleared and will be accessible.

■ **Clear (Mouse: Left click)**

Press this button to clear the HDD. A confirmation dialog will be shown on the screen. Press **YES** to confirm, or **CANCEL** to cancel.

Note: If the HDD has not been formatted, it will be formatted and partitioned with default record size, **100% for Alarm record and 0% for Normal record**. If it has been formatted (and recorded), it will be partitioned according to the Alarm Record Size (%) and Normal Record Size (%) displayed on the screen and the previously recorded contents will all be cleared.

■ **Physical Format (Mouse: Left click)**

Press this button to physically format the selected HDD. A confirmation dialog will be shown on the screen. Press **YES** to confirm, or **CANCEL** to cancel. **Please note that the recording will be always optimized for performance & lifetime no matter it's for the first time or for the one hundredth time. The formatting would take less than 1 minute. We strongly recommend that the user use this physical format function to format the HDD for the first time.**

Note: The HDD will be physically formatted and partitioned with default record size, **100% for Alarm record and 0% for Normal record**. All the previously recorded contents will be cleared.

Following is a brief description for each item and its specific operations:

- **Size (GB)** – the total storage in GB (Giga-Byte) for the HDD if it has been formatted. This item is just for information.
- **Alarm Record (%)** – Alarm Record Size (in percentage) for this HDD. Please follow the Text Input method described in [Section 4.1](#) to change the value. **Please note that if the alarm record percentage for all HDDs is zero, the alarm video/audio will be recorded in normal record partition. If the total normal record size is zero, the normal video/audio will be recorded in alarm record partition.**
- **Normal Record (%)** – Normal Record Size (in percentage) for this HDD. It equals to (100% - Alarm Record Size). This item is just for information.
- **NAS/Setup** – used to setup NAS (Network Attached Storage) related parameters if NAS is connected to the DVR. Press **Setup (Mouse: Left click)** to call up NAS Setup display as shown.

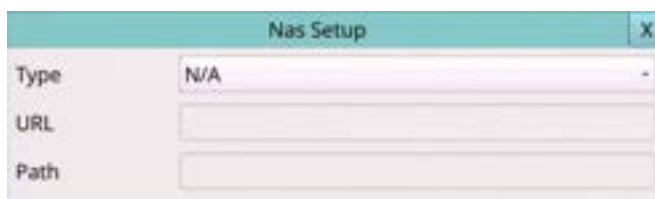

Following is a brief description for each item and its specific operations:

- **Mouse: Click in the respective item**
Select the items to set.
- **X (Mouse: Left Click X or Right Click to leave)**
Press this button to escape from this screen, and return to HDD Format/Clear Setup display. If the contents have been modified, a Save dialog will be shown to ask the user to save the changes, press **YES** to exit and save, **CANCER** to exit without saving. **Please note that if the NAS settings are changed, the user will be asked to reboot the system for the new settings to take effect. The NAS device will be always the last storage in the HDD list.**
- **Type** – “NFS” or “N/A”.
- **URL** – the URL (Uniform Resource Locators) for the NAS device. Please follow the Text Input method described in [Section 4.1](#) to modify this item.
- **Path** – the path in the NAS device to store video/audio. Please follow the Text Input method described in [Section 4.1](#) to modify this item. **Please note that lowercase and uppercase are treated differently. Besides, '/' is used for subdirectory.**

6.5.2 Advanced HDD Setup

In HDD Setup, press **Advanced HDD Setup** to call up Advanced HDD Setup as shown.

The HDD Failure Action in Advanced HDD Setup allows the administrator to define how the system responds to the detected HDD failure, while the Privacy settings allow the administrator to set the DVR to record for Limited Period and the Retention Period of its HDD storage. **The HDD Failure Action will be triggered if there's no available formatted HDD detected.**

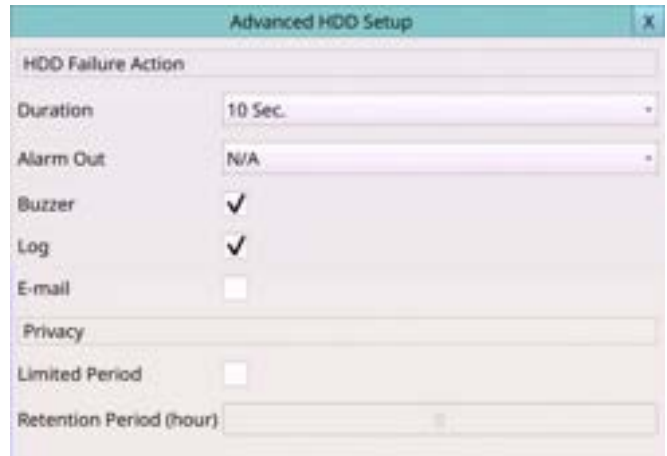

The general operations are as below:

- **Mouse: Click in the respective item**

Select the items to set.

- **X (Mouse: Left Click X or Right Click to leave)**

Press this button to escape from this screen, and return to HDD Setup display. If the contents have been modified, a Save dialog will be shown to ask the user to save the changes, press **YES** to exit and save, **CANCER** to exit without saving.

Following is a brief description for each item and its specific operations:

- **Duration** – response duration to define at most how long (in seconds) the Alarm Out relay and the Buzzer will keep being triggered after HDD failure is detected. The value (3 seconds - 60 minutes, discrete, '-' for 'Forever').
- **Alarm Out** – to define which Alarm Output will be triggered when this event is triggered. **Alarm Output Source Setup up to 32 alarm outputs can be selected, and the definitions are similar to alarm inputs.**
- **Buzzer** – to activate the internal Buzzer or not when HDD failure is detected.
- **Log** – to log to event logs or not.
- **Notification** – **to notify mobile phones and/or send the event e-mail to remote station or not.** The mobile phones with alarm notification from the DVR enabled will be notified, and the e-mail will be sent to the predefined receivers when the event is triggered.
- **Limited Period** – whether the HDD storage is for a limited period or not. The setting “-” means No.
- **Retention Period (hour)** – the retention period of the HDD storage if Limited Period is “~”. Please follow the Text Input method described in [Section 4.1](#) to modify this item. If this item is set as 0, it will be treated as No Limited Period.

6.6 Password Setup

Left-click the mouse to select the **Password** (Mouse: ) In Setup Menu display, the Password Setup will be shown.

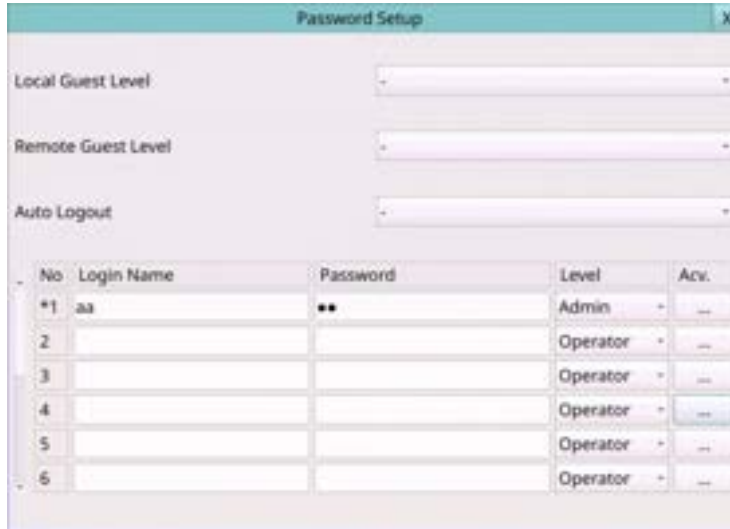

No.	Login Name	Password	Level	Act.
*1	aa	11	Admin	...
2			Operator	...
3			Operator	...
4			Operator	...
5			Operator	...
6			Operator	...

The Password Setup allows the administrator to add new users, delete existing ones, and/or modify the user's name, password, and/or level.

There are three default password levels in the system, including **Administrator** (highest), **Supervisor**, and **Operator** (lowest). The Operator can operate live video display, the Supervisor live video display, image playback and archive, and the Administrator everything. Beside the default password levels, the user can also set "Customized" user level as described in the following paragraphs. The system allows up to 18 user accounts.

There is one factory-preset login name/password aa/11 at **Administrator** level. The user can use it to login the system for the first time.

The general operations are as below:

- **Mouse: Click in the respective item**

Select the items to set.

- **X (Mouse: Left Click X or Right Click to leave)**

Press this button to escape from this screen, and return to Setup Menu display. If the contents have been modified, a Save dialog will be shown to ask the user to save the changes, press **YES** to exit and save, **CANCER** to exit without saving.

- **Select/Deselect as default (Mouse: Left click)**

To select/deselect the user, click the number text and there will be an asterisk (*) preceding the number for the default login user. And this login name/password will be the default one each time the login dialog is shown, so the user doesn't bother to enter the text to log in to the system.

Following is a brief description for each item and its specific operations:

- **Local Guest Level** – the local access level (**Administrator, Supervisor, Operator, -,** or any user) without login the system.
- **Remote Guest Level** – the remote access level without login the system.
- **Auto Logout** – auto logout, if there's no user's operation in 1 minute to 24 hours, or not ("-").
- **Login Name** – please follow the Text Input method described in [Section 4.1](#) to modify this item.
- **Password** – this item accepts numbers only. Please follow the Text Input method described in [Section 4.1](#) to modify this item.
- **Level** – the password level (**Administrator, Supervisor, Operator, or Customized**) for this user.
- **Adv.** – press ... (**Mouse: Left click**) to call up Advanced User Setup as shown below.

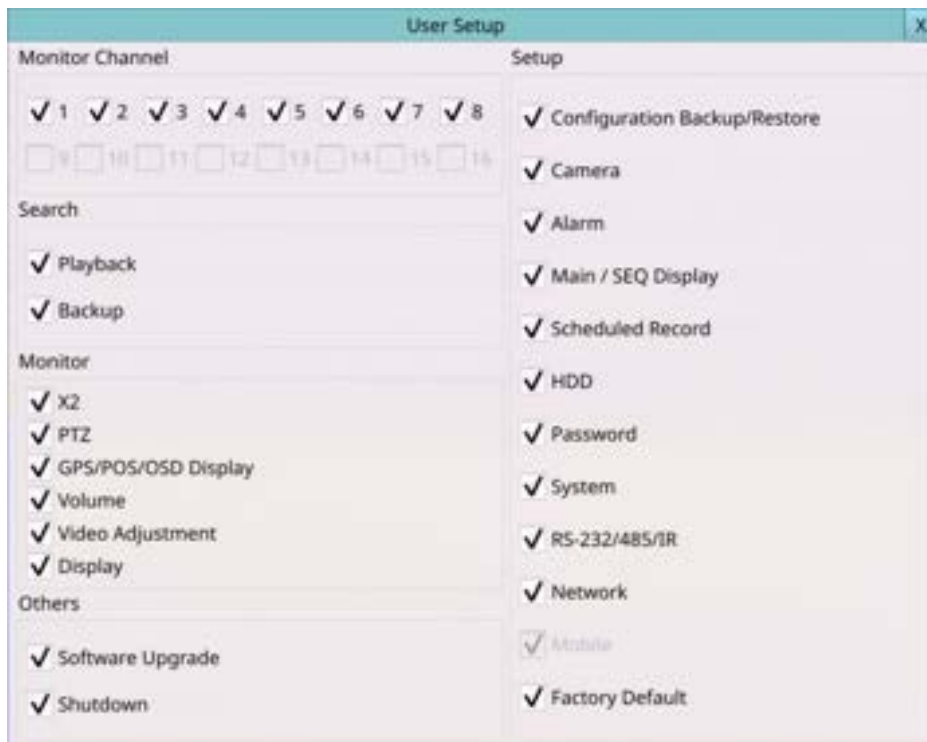

The Advanced User Setup allows the administrator to setup each user's detailed access right of the system.

The general operations are as below:

- **Mouse: Click in the respective item**
Select the items to set.

- **X (Mouse: Left Click X or Right Click to leave)**
Press this button to escape from this screen, and return to Password Setup display.
The Password Setup contents will be updated accordingly.

Following is a brief description for each item and its specific operations:

Monitor Channel:

- **Monitor Channel 1-4/8/16** – the user can only monitor those channels “checked”.
Mouse Left click to check/uncheck this item.

Search:

- **Playback** – to enable the user to playback video/audio if “checked”. **Mouse Left click** to check/uncheck this item.
- **Backup** – to enable the user to backup video/audio if “checked”. **Mouse Left click** to check/uncheck this item.

Monitor:

- **X2** – to enable the user to do X2 operation for live/playback video if “checked”.
Mouse Left click to check/uncheck this item.
- **PTZ** – to enable the user to do PTZ operation if “checked”. **Mouse Left click** to check/uncheck this item.
- **GPS/POS/OSD Display** – to enable the user to change GPS/POS/OSD Display if “checked”. **Mouse Left click** to check/uncheck this item.
- **Volume** – to enable the user to change volume if “checked”. **Mouse Left click** to check/uncheck this item.
- **Video Adjustment** – to enable the user to do video adjustment operation if “checked”. **Mouse Left click** to check/uncheck this item.
- **Display** – to enable the user to change display settings if “checked”. **Mouse Left click** to check/uncheck this item.

Setup:

- **Configuration Backup/Restore** – to enable the user to backup/restore configurations if “checked”. **Mouse Left click** to check/uncheck this item.
- **Setup Camera** – to enable the user to do Camera Setup if “checked”. **Mouse Left click** to check/uncheck this item.
- **Setup Alarm** – to enable the user to do Alarm Setup if “checked”. **Mouse Left click** to check/uncheck this item.
- **Setup Main/SEQ Display** – to enable the user to do Main/SEQ Display Setup if “checked”. **Mouse Left click** to check/uncheck this item.
- **Setup Scheduled Record** – to enable the user to do Scheduled Record Setup if “checked”. **Mouse Left click** to check/uncheck this item.

- **Setup HDD** – to enable the user to do HDD Setup if “checked”. **Mouse Left click** to check/uncheck this item.
- **Setup Password** – to enable the user to do Password Setup if “checked”. **Mouse Left click** to check/uncheck this item.
- **Setup System** – to enable the user to do System Setup if “checked”. **Mouse Left click** to check/uncheck this item.
- **Setup RS-232/485** – to enable the user to do RS-232/485 Setup if “checked”. **Mouse Left click** to check/uncheck this item.
- **Setup Network** – to enable the user to do Network Setup if “checked”. **Mouse Left click** to check/uncheck this item.
- **Setup Factory Defaults** – to enable the user to restore factory defaults to all setup related configurations if “checked”. **Mouse Left click** to check/uncheck this item.

Others:

- **Software Upgrade** – to enable the user to upgrade DVR software if “checked”. **Mouse Left click** to check/uncheck this item.
- **Shutdown** – to enable the user to shutdown the DVR if “checked”. **Mouse Left click** to check/uncheck this item.

6.7 System Setup

Left-click the mouse to select the **System** (Mouse: ) In Setup Menu display, the System Setup will be shown.

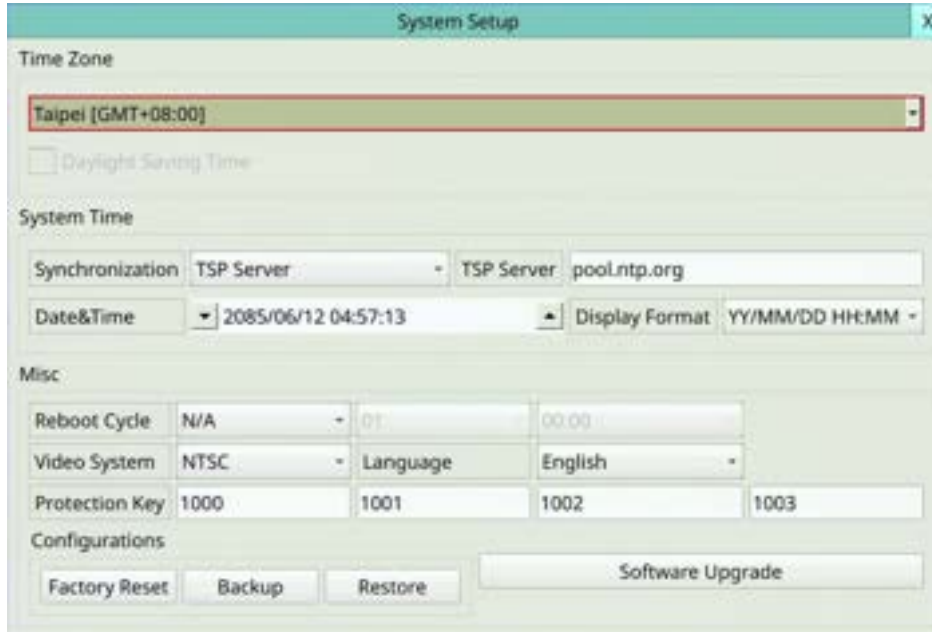

The System Setup allows the administrator to set the system time, time zone, time synchronization, language, etc.

The general operations are as below:

- **Mouse: Click in the respective item**
Select the items to set.
- **X (Mouse: Left Click X or Right Click to leave)**
Press this button to escape from this screen, and return to Setup Menu display. If the Save dialog is shown, press **YES** to exit and save, **CANCEL (Mouse: Right Click)** to exit without saving.

Following is a brief description for each item and its specific operations:

- **Time Zone** – Select the time zone for the system. Please refer to [Appendix A](#) for the time zone table.
- **Daylight Saving Time** – **Mouse Left click** to check/uncheck this item. The default value is set by selecting a different time zone, but the user may check/uncheck this item if the default setting is checked.
- **Synchronization** – time synchronized with TSP Server or not. **Please note that “Local Server” means this DVR is used as TSP server.**
- **TSP Server** – TSP (Time Synchronization Protocol) server name if Time Synchronization is set to “TSP Server”. The system will try to do time synchronization with the specified TSP server at the system preset interval. Please follow the Text Input method described in [Section 4.1](#) to modify this item.

- **Date & Time** – system date and system time.
- **Display Format** – format used for the system time displayed on the lower-right corner of the main screen.
- **Reboot Cycle** – It can be set to restart the device according to the schedule of **N/A**, **Daily**, **Weekly**, and **Monthly**.
- **Video System** – NTSC or PAL.
- **Language** – Select the language for the system. The languages supported include: **English**, **Simplified Chinese**, **Traditional Chinese**, etc.
- **Protection Key** – the protection key for the remote access of the system. Please follow the Text Input method described in [Section 4.1](#) to modify these items.

Note: This protection key will be used for authentication when any remote station wants to connect with the system from Ethernet interface, either LAN or internet. So, the same protection key must be entered to install the remote software if it is to be used to access the system.

- **Factory Reset** – reset all the settings to factory default values.
- **Backup** – backup the configurations and **QR code image** of this unit to the corresponding USB device. **The user may enter the directory to back up the configurations to.**

Note: The QR code image can be used to connect to device via select this image from HEM device list.

- **Restore** – restore the configuration files in the corresponding backup device to this unit. **The user may enter the directory to restore the configurations from.**
- **Software Upgrade** – press **OK (Mouse: Left click)** to start the upgrade process when the highlighted file is a correct upgrade file. A confirmation dialog will be shown on the screen. Press **YES** to confirm to upgrade the system software.

Note : After the software is upgraded, the system will restart immediately. The split window display will be shown after restart, please wait a moment.

6.8 RS-232/485/IR Setup

Left-click the mouse to select the **RS-232/485/IR** (Mouse: ) In Setup Menu display, the RS-232/485/IR Setup will be shown.

RS-232 / 485 / IR Setup		
COM Port	RS-232	RS-485
Device Type	N/A	POS
Model	Terminal	Epson General
Baud Rate	1200	9600
Data Bit	5	8
Stop Bit	1	1
Parity	None	None
DVR/Camera ID	0	1
IR		

The RS-232/485/IR Setup allows the administrator to setup RS-232/RS-485 control port and DVR ID for IR remote. Please refer to the manuals for the connected devices to set the items in RS-232/485 Setup.

The general operations are as below:

■ **Mouse: Click in the respective item**

Select the items to set.

■ **X (Mouse: Left Click X or Right Click to leave)**

Press this button to escape from this screen, and return to Setup Menu display. If the Save dialog is shown, press **YES** to exit and save, **CANCEL (Mouse: Right Click)** to exit without saving.

Following is a brief description for each item and its specific operations:

■ **Device Type** – **PTZ, Keyboard, GPS, POS, PTZ+Keyboard** or **N/A** (Not Available). Press ▼ button to change the type.

■ **Model** – PTZ model, GPS protocol, or POS printer type of the connected devices. The PTZ models supported include **Pelco D protocol Dome, SamSung SCC-641P, Kalatel Cyber Dome, PIH-series, Dynacolor, Bosch AutoDome, Video Trek**, etc. The GPS protocol supported is **NMEA0183**. **The POS printer types supported include Epson General** (EX. **Epson-TM200, Epson-TMU300, Epson-TMU675, Epson-TMT882, Epson-RPU420, and Epson-MD332S**) **and Epson-TMU295**. Press ▼ button to change the supported model (or protocol).

■ **Baud Rate** – **for Multiple POS, please set the Baud Rate setting as 9600**. Press ▼ button to change the value.

■ **Data Bit** – press ▼ button to change the value.

■ **Stop Bit** – press ▼ button to change the value.

■ **Parity** – (**Odd, Even, or None**). Press ▼ button to change the value.

- **DVR/Camera ID** – for **PTZ** => the device ID for this digital video/audio recorder, and it must not conflict with the other devices connected in the same control port.; for **GPS/POS** => the Camera ID to receive the GPS/POS data. **For Multiple POS, please set the DVR/Camera ID setting as Multiple.** For **IR** => the **DVR ID** to receive the IR control signal, “-” to receive any DVR ID signal. Press ▼ button to change the ID.

Note: For Multiple POS, please make sure to setup the ID of protocol converter I-7524 correctly ([Appendix D](#)).

6.9 OSD Setup

Left-click the mouse to select the **OSD** (Mouse: ) In Setup Menu display, the OSD Setup will be shown.



The OSD Setup allows the administrator to set up the OSD display on the split window.

The general operations are as below:

- **Mouse: Click in the respective item**
Select the items to set.
- **X (Mouse: Left Click X or Right Click to leave)**
Press this button to escape from this screen, and return to Setup Menu display. If the Save dialog is shown, press **YES** to exit and save, **CANCEL (Mouse: Right Click)** to exit without saving.

Following is a brief description for each item and its specific operations:

- **Title** – On/Off. Set display camera title on split window or not.
- **Time** – On/Off. Set display system time on split window or not.
- **Message** – On/Off. Set display system message on split window or not.
- **Status** – On/Off. Set display status on split window or not.
- **Rec. %** – On/Off. Set display HDD record% on split window or not.
- **GPS** – On/Off. Set display GPS data on split window or not.
- **POS** – different Color. Set display POS color on split window or not.

7. Search/Playback/Archive (Administrator, Supervisor)

There are five ways to search the recorded video/audio for playback:

- (a) Search by time,
- (b) Search by event,
- (c) Search archived files, and
- (d) POS search.

Left-click the mouse to select the **Search** (Mouse: ) In Menu display, the Search will be shown.

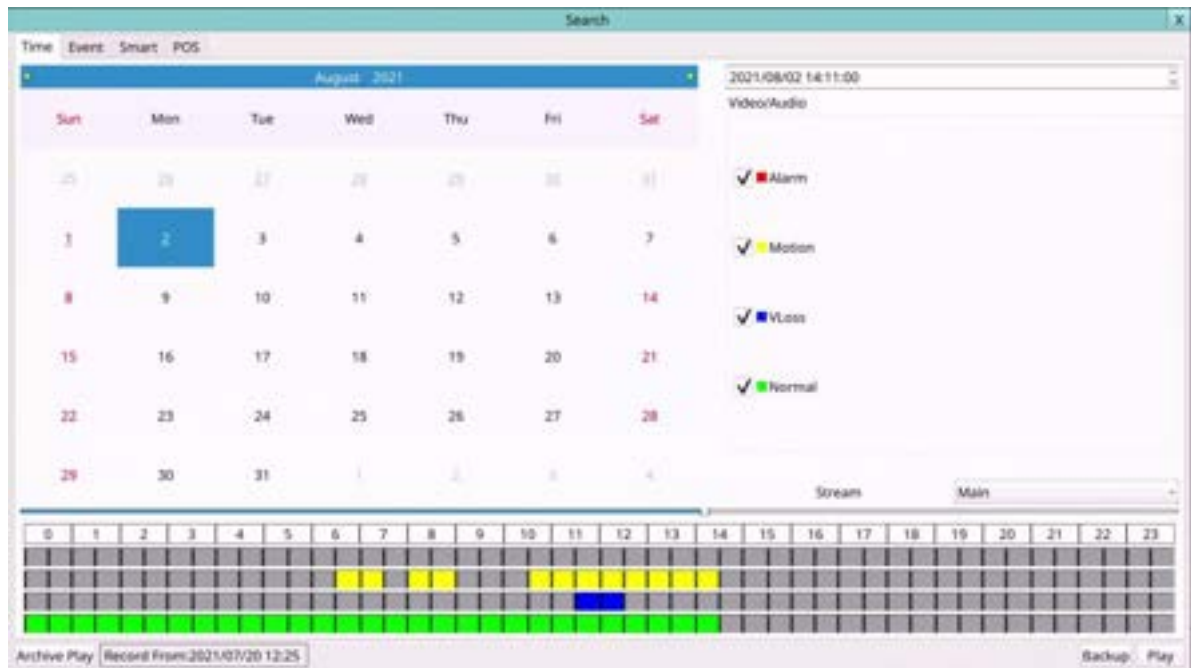

The user's operations are described as the followings:

- **Mouse: Click in the respective item**
Select the items to enter the corresponding Search display.
- **X (Mouse: Left Click X or Right Click to leave)**
Press this button to escape from this screen, and return to split-window display.

The Search displays and their operations are described in the following sections, followed by the playback operations of the searched video/audio.

Note: In split-window display, the user can press **PLAY** button (Mouse: ) to call up **Instant Playback Menu**. Select the **Stream Type**, then select the **Time** for instant playback.



7.1 Search By Time

The screen for Search By Time is shown as below:



The Status field will show the 'Recorded from' time, it's based on the Video/Audio before searching. Above the status, fields are the 24H time slider and alarm/motion/video loss/normal recording status (from top to bottom).

The general operations are as below:

- **Mouse: Click in the respective item**
Select the items to enter the corresponding Search display.
- **X (Mouse: Left Click X or Right Click to leave)**
Press this button to escape from this screen, and return to split-window display.
- **Play Button (Mouse: Left click)**
Press this button to start playing the recorded video/audio with the selected search time and video/audio type. If there's no camera in playback mode, all the cameras in the current split window will be set to playback mode.
- **Backup Button (Mouse: Left click)**
Press this button to **backup (copy)** the selected type of recorded video/audio starting from the **Search Time** (described below) in the HDD to the connected backup device **without playback**. The Backup display (described in [Section 7.6](#)) will be shown. **Please note that this kind of backup is performed in the background, and the user can still do almost all the operations.**
- **Archive Play Button (Mouse: Left click)**
Press this button to **search/playback archive files** from the backup device. The Archive Play screen (described in [Section 7.4](#)) will be shown.

Following is a brief description for each item and its specific operations:

- **Stream – (Main Stream, Sub Stream)**. Select the stream of the recorded video you want to search for playback.

- **Search Time** – (Year, Month, Date, Hour, Minute) for the recorded video/audio. The playback (or backup) will start from the time entered here when the user press the playback buttons (or Copy button) later. Press ▲ ▼ buttons to modify each item. Users can also select the calendar on the left by mouse click and select the time by mouse dragging the slider icon.
- **Video/Audio** – (Alarm, Motion, Video Loss, Normal). Check the types of the recorded video/audio you want to search for playback. Mouse Left click to check/uncheck each item.

7.2 Search By Event / Log Display

The screen for Search By Event - Log display is shown as below:

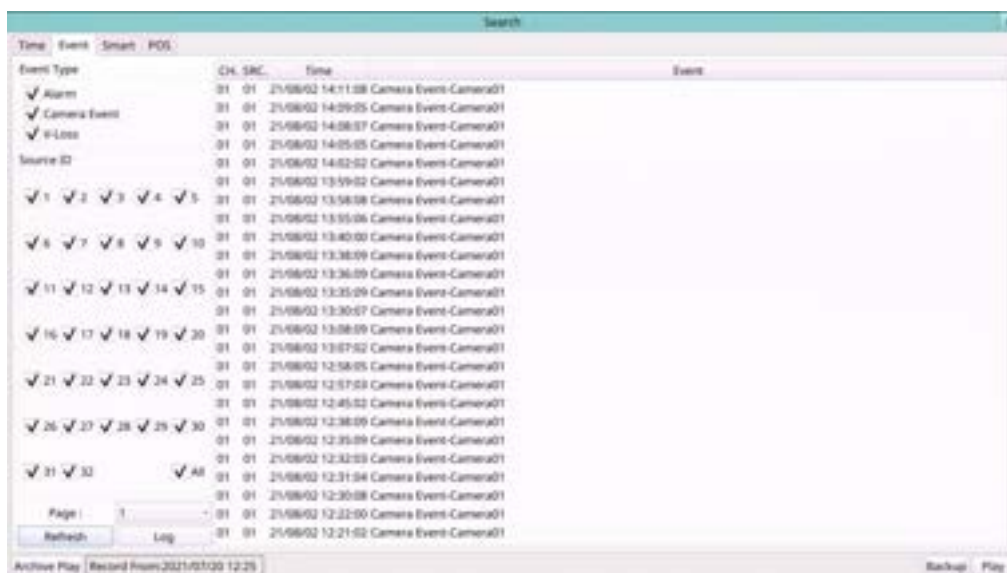

There are three different types of event logs, including Alarm, Camera Event, Video Loss. And up to 6000 most recent event logs can be stored in the system.

The general operations are as below:

- **Mouse: Click in the respective item**
Select the items to enter the corresponding Search display.
- **X (Mouse: Left Click X or Right Click to leave)**
Press this button to escape from this screen, and return to split-window display.
- **Refresh Button (Mouse: Left click)**
Press this button to refresh the log display. If there are new event logs after the screen is last updated, the log list shown will be updated accordingly.
- **Log Button (Mouse: Left click)**
Press this button to export the event log to backup device. The **Save To File dialog** will be shown as below.

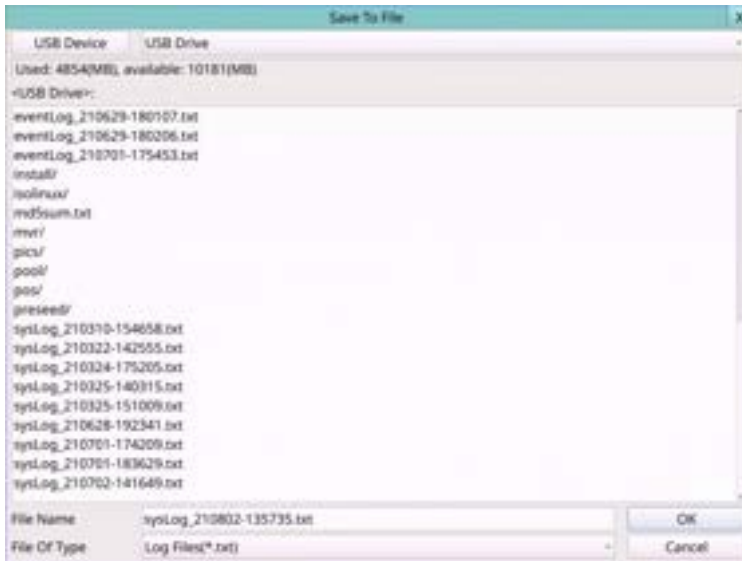

Please select the backup device, and enter the directory name you want, and then press **OK** to copy the event log to the selected backup device.

■ **Page (Mouse: Left click)**

Press the Numeric to select the page of the event logs, the log list will also be updated.

Following is a brief description for each item and its specific operations:

- **Event Type** – the type of events (**Record, Alarm, Motion, Video Loss**) to be shown in the log list. **Mouse Left click** to check/uncheck the event type for the log list.
- **Source ID** – the source which triggered the event. For Alarm, it's the alarm input number; for Camera Event and Video Loss, it's the camera number. It's used to filter the events to be shown in the log list. **Mouse Left click** to check/uncheck each item. **You may check/uncheck "All" for faster operation.**
- **Log List** – the event logs according to the Event Type and Source ID selected. The user may (1) **Mouse Left click** to select/deselect the highlighted log in this list, (multiple logs can be selected in this way) (2) press **Play Buttons (Mouse: Left click)** to playback all the selected logs, or (3) press **Backup Button (Mouse: Left click)** to **backup (copy)** all the selected recorded video/audio to the connected backup device **without playback**. The Backup display (described in [Section 7.6](#)) will be shown. **Please note that this kind of backup without playback is performed in the background, and the user can still do almost all the operations.** Please refer to [Section 7.7 Playback For Search By Event](#) for the detailed operations for event playback.

7.3 Search Archived Files

The screen for Search Archived Files is shown as below:

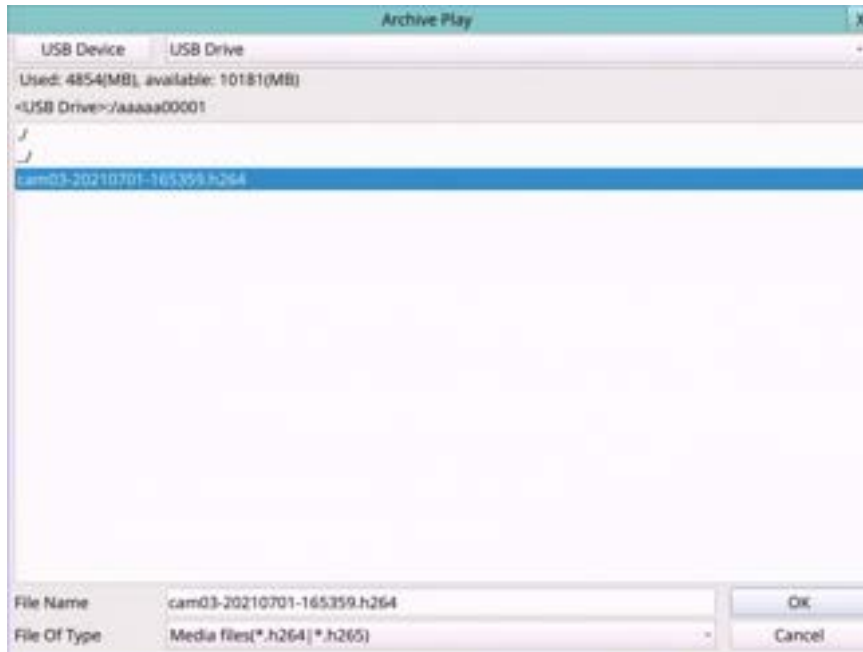

The operations are as below:

- **Mouse: Click in the respective item**
Select the items to enter the corresponding Search display.
- **X (Mouse: Left Click X or Right Click to leave)**
Press this button to escape from this screen, and return to split-window display.

Following is a brief description for each item and its specific operations:

- **USB Device** – press **USB Device (Mouse: Left click)** to call up Backup Device dialog (if there's no Backup device connected).
- **Disk Storage** – to select the disk storage to search the archived files.
- **Archived File List** – the archived files in the selected Disk Storage. Please **Mouse Left click** to select the file in this list, then press **Play Button** or **Mouse Left click twice** to playback it directly. Please refer to [Section 7.9 Playback For Archived Files](#) for the detailed operations.



Note : The format of the filename is camNN-YYYYMMDD-hhmmss.h264, where NN stands for camera number, YYYY year, MM month, DD date, hh hour, mm minute, and ss second.

7.4 POS Search

The screen for POS Search is shown as below:

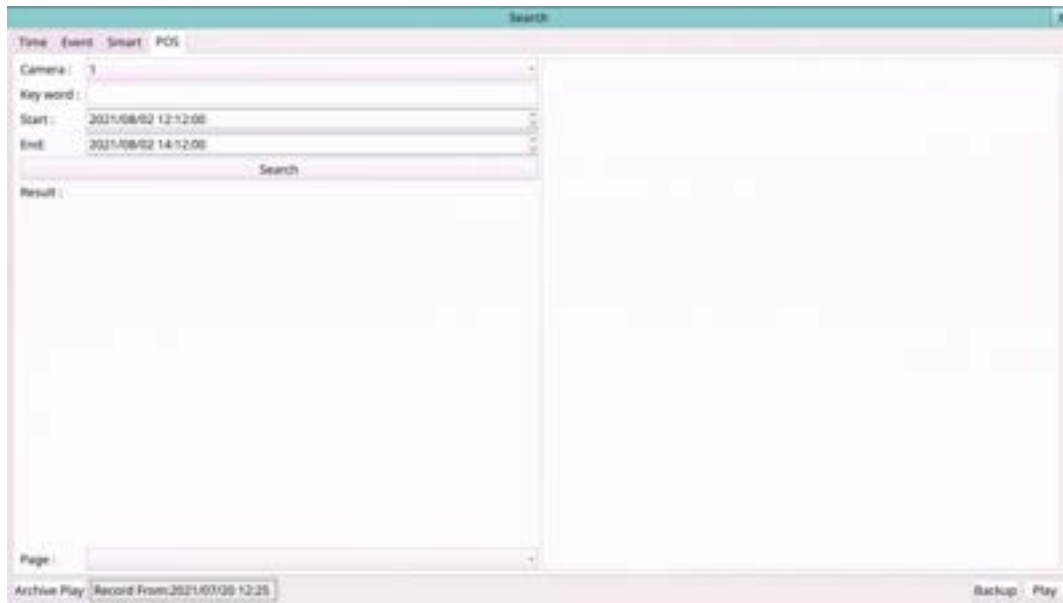

The Status field will show the 'Recorded from' time in the HDDs before searching or the search result after searching.

The general operations are as below:

- **Mouse: Click in the respective item**
Select the items to enter the corresponding Search display.
- **X (Mouse: Left Click X or Right Click to leave)**
Press this button to escape from this screen, and return to split-window display.
- **Search (Mouse: Left click)**
Press this button to start searching the recorded video/audio with the selected search time, camera, and key word. The search result will be shown on the right half of this dialog. **To prevent the system from overloading by POS Search, up to 500 matched files or 200 GB of HDD storage for each record partition, alarm or normal, from the start time will be searched.**
- **Page (Mouse: Left click)**
Press the Numeric to select the page of the event logs, the log list will also be updated.

Following is a brief description for each item and its specific operations:











- **Camera ID** – the camera to be searched for matched files. Press the Numeric to change the camera ID.
- **Key word** – the key word for the POS data of the camera to be searched for matched files. **The POS data containing the key word will be selected as matched.** If key word is empty, all POS data will be selected. Please follow the Text Input method described in [Section 4.1](#) to input this item.

- **Start/End Time** – (Year, Month, Date, Hour, Minute) for the POS data for the recorded video/audio. The files will be searched from the start time to the end time entered here when the user press the **Search** button later for the matched files. Press ▲ ▼ buttons to modify each item.

- **Matched file List** – the matched files (HDD ID & time are shown) according to the selected search time, camera, and key word. The files are shown from the oldest to the newest. The user may (1) **Mouse Left click** to enter POS Search Playback display of the selected matched file in this list, (2) press **Play Button (Mouse: Left click)** to playback it directly, or (3) press **Backup Button (Mouse: Left click)** to **backup (copy)** the selected recorded video/audio to the connected backup device **without playback**. The Backup display (described in [Section 7.6](#)) will be shown. **Please note that this kind of backup without playback is performed in the background, and the user can still do almost all the operations.** Please refer to [Section 7.10 Playback/Archive For POS Search](#) for the detailed operations for POS search playback.

7.5 Playback/Archive for Search By Time

Please refer to [Section 4.3 Basic Operations](#) for how to change the camera(s) in the live view and playback windows. You may use the following buttons to control the playback:

- **Play/Pause Button (Mouse: )**
Press this button to play the recorded video/audio searched at forward speed 1X, or pause the playback. If the playback is paused, press this button again to resume playing. Note that audio can only be played at forward speed 1X.
- **Stop Button (Mouse: )**
Press this button to stop playing the recorded video/audio. If the user press  button later, the playback will start from the beginning.
- **Fast Forward Button (Mouse: )**, **Slow Forward Button (Mouse: ) => (Mouse:  to toggle)**
Press this button for fast/slow forward playback. Each time this button is pressed, the forward playback speed will become faster/slower, from 2X, 4X, 8X, up to 64/16X, and then back to 2X.
- **Fast Backward Button (Mouse: )**, **Slow Backward Button (Mouse: ) => (Mouse:  to toggle)**
Press this button for fast/slow backward playback. Each time this button is pressed, the backward playback speed will become faster/slower, from 2X, 4X, 8X, up to 64/16X, and then back to 2X.
- **Single Step Button (Mouse: )**
Press this button to play the recorded images frame by frame.
- **Copy (Mouse: )**
Press this button to copy or stop copying the playback video/audio to the storage device connected to the USB port. The **Backup display** will be shown as below. Press ... button to set the directory to back up the data, then press **Apply** button to copy data to drive.

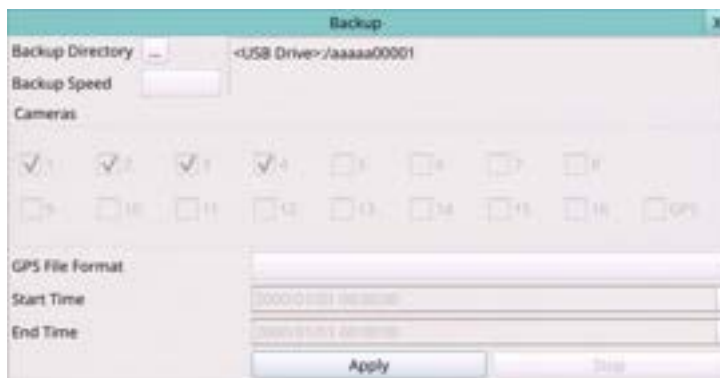

Following is a brief description for the operations in Backup display:

- **Mouse: Click in the respective item**

Select the items to enter the corresponding display.

■ **X (Mouse: Left Click X or Right Click to leave)**

Press this button to escape from this screen, and return to split-window display.

■ **Apply Button (Mouse: Left click)**

Press this button to start back up (copy) or apply the revised settings. If it's copying, press this button to return to the previous display. There will be a Copy status on the lower middle indicating that the selected video/audio is being archived to the storage device. For DVD disc, the files won't be written to the disc until the storage size reaches 1 GB or the user stop copying. Writing to the disc may take more than 1 minute for every 100 MB (depending on the disc type).

■ **Stop Button (Mouse: Right Click)**

Press this button to stop copy and escape from this screen. It will return to the split-window display.

The description for each item and its specific operations is as below:

- **Backup Device** – the backup device connected to the system. Press **USB Device (Mouse: Left click)** on the Backup Directory display to call up **Backup Device dialog** if there's no backup device connected. **Mouse Left click** buttons to select the connected device. **Connect the backup device before copying.**

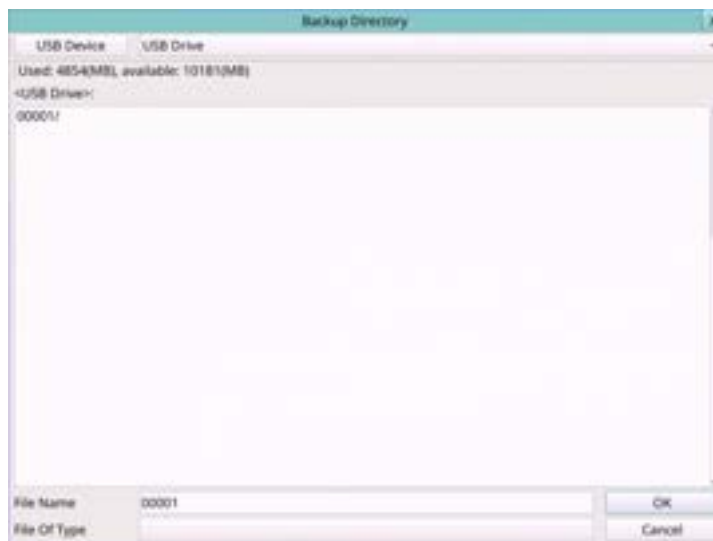

- **Connect/Disconnect** – If the backup device is disconnected (as shown in Current Status), please plug the device in the USB port and/or insert a DVD for the DVD device, and then **Mouse Left click** the **Connect** button to command the system to connect with it. If the device is already connected (EX. R/W - Read/write, as shown in Current Status), please **Mouse Left click** the **Disconnect** button to command the

system software to disconnect with the device and then unplug the device from the backup port.

Note 1: DO NOT format the DVD for better performance and compatibility.

Note 2: Before using a USB pen drive, please format it to FAT32 or exFAT file system by MS-Windows.

Note 3: The backup device has to be connected by the system software before it can be used to read/write. If it failed to connect, please unplug the device, and then plug the device in the USB port again.

Note 4: Some backup devices may have compatibility problems. Please contact your local dealer or installer for the supported devices.

■ **Backup Speed** – 1-9, with 1 the lowest speed, 9 the highest speed. Press the Numeric to select the value.

■ **Directory** – the directory to store the archived files. Please follow the Text Input method described in [Section 4.1](#) to input the directory.

■ **Cameras** – the video/audio of the cameras to be archived. **Mouse Left click** to select/deselect each of the selectable cameras. **If the camera with GPS data is selected, the GPS data will be saved with the camera video in the same file. The user may save GPS data only (without saving camera video) by selecting GPS.**

■ **GPS File Format** – for the backup of GPS data only. The supported formats are TXT and KML. **Mouse Left click** to select the value.

■ **End Time** – (Year, Month, Date, Hour, Minute) for the recorded video/audio for the **backup without playback** of **Search By Time**. The files will be backup from the start time to the end time when the user press the **COPY** button (**Mouse: Left click**) to start copying. Press ▲ ▼ buttons to modify each item.

■ **Search Button (Mouse: )**

Press this button in playback to display the playback seek slider bar as shown below.

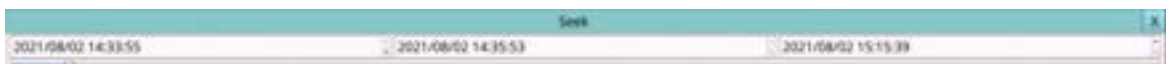

The left-most is the start time and its slider, the right-most is the end time and its slider, and the middle is the current playback time and its slider. Following is a brief description of the operations in the playback slider bar:

■ **Mouse: Click in the respective item**

Select the items to enter the corresponding display.

■ **X (Mouse: Left Click X or Right Click to leave)**

Press this button to not show the playback slider bar.

■ **▲ ▼ (Mouse: Left click)**

Press these buttons to change the time after click the time. After change the left-most start time and the right-most end time, the whole playback slider bar will be updated accordingly.

■ **Mouse Left click and drag to slider the bar**

Mouse Left click and pull to slider the bar to change the middle current playback time.

Except the playback buttons, the user can still do all the other operations in split-window display. Please refer to [Section 4.3 Basic Operations](#) for the operations of the other buttons.

Note : The format of the GPS filename is YYYYMMDD-hhmmss.txt (or .kml), where YYYY stands for year, MM month, DD date, hh hour, mm minute, and ss second. GPS file can be displayed in the archived file list, but cannot be played. Please use GPS applications such as Google Earth, PaPaGO, etc. to read/convert its contents.

Note : When backing up, the backup data according to the selected stream type. If the main stream is selected, the backup data is the main stream. If the sub-stream is selected, the backup data is the sub-stream.











Note : For each camera and each backup, a batch file will be generated as well as the backup files. A directory “/SelfPlayer” will also be generated if it’s not existing in the backup storage device. The user can use the batch file to self-playback the corresponding backup files in a PC. If the PC has not been installed with the required player components, those components will be installed by running the batch file. For some Windows, please run /SelfPlayer/SelfPlayerInstall.exe manually to install the required player components. **If want to copy self-playback files, please copy the batch file and the backup files to the destination directory, and copy the whole directory “/SelfPlayer” to the root directory of the destination device.**

Note : For use MS-Windows HEM Utilities (H.265/264 to AVI/MP4 Conversion Utility), the converted .AVI or .MP4 files can be played by Windows Media Player. The DivX (<http://www.divx.com/>) or the other H.265/264 decoder should be installed in the PC to play media files.

7.6 Playback/Archive for Search By Event

In Log display, press **Play Buttons** () (**Mouse: Left click**) to playback the selected logs. This display is the same as full screen display of the main display, and the playback buttons are effective.



The operations are as below:

- **Playback Buttons** (, , , , , , , , , ) (**Mouse: Left click**)
These buttons are all the same as in [Section 7.6 Playback/Archive For Search By Time](#).
- **The Other Buttons**
All the other buttons are the same as in [Section 4.3 Basic Operations](#).

7.7 Playback for Archived Files

In Search Archived Files display, Please **Mouse Left click** to select the file in this list, then press **Play Button** or **Mouse Left click twice** to playback it directly. This display is the same as full screen display of the main display, and the playback buttons are effective.

The operations are as below:

- **Playback Buttons** () (**Mouse: Left click**)
These buttons are all the same as in [Section 7.6 Playback/Archive For Search By Time](#).
Please note that **COPY** button () is not effective in this display.
- **The Other Buttons**
All the other buttons are the same as in [Section 4.3 Basic Operations](#).

7.8 Playback/Archive for POS Search

In POS Search display, Press the Play Button (**Mouse: Left click**) to playback the selected matched file directly in the POS Search display. This display is the same as full screen display of the main display, and the playback buttons are effective.

The operations are as below:

- **Playback Buttons** () (**Mouse: Left click**)
These buttons are all the same as in [Section 7.6 Playback/Archive For Search By Time](#).
- **The Other Buttons**
All the other buttons are the same as in [Section 4.3 Basic Operations](#).

8. Remote Access

8.1 PC Remote Access

The digital video/audio recorder can be accessed by using a web browser installed on a PC if this unit is connected to a network, either internet or intranet.

Before Logging On

Before accessing this unit through web browser, please make sure the followings (**For most PCs, only step 4 is needed!**):

1. This unit is connected to the network correctly, and the configurations are all setup correctly. Please refer to [Section 5.5 Network Setup](#) for the detailed configurations.
2. **DirectX® End-User Runtime 9.0** or above has been installed in your PC successfully. If not, please logon to <http://www.microsoft.com> to get the free download of it.
3. The domain name or IP address of the digital video/audio recorder has been set as **trusted web site** in your PC, and the **(https:) server verification** for trusted web site is **unchecked**. If not, please go to Tools → Options → Security in your I.E. to do the settings. **For I.E. 7, please set the Security level for this zone to Low.**
4. The ActiveX control in your PC is not disabled. If you are not sure, please go to Tools → Options → Security → Custom in your I.E. to enable ActiveX control.
5. Port 67 (control port) or port 68 (data port) is not blocked out by your router or ISP (Internet Service Provider).
6. If the PC has used I.E. to access earlier software version of DVR, please go to Tools → Options → General in your I.E. to **delete “Temporary Internet files” and all offline contents**.
7. Please go to Start → Setup → Control, select Display → Settings, and set the Screen Resolution to at least 1024x768 and Color to 32-bit.

Note: If trusted web site is not set, please follow the instructions on the screen to download the manual package, logon the PC as administrator, and install the package in the PC. After the package is installed, users should be able to logon to the DVR successfully.

Logon

After the above-mentioned items have been done correctly, restart your web browser and enter the domain name or IP address of the digital video/audio recorder in the Location/Address field of the web browser (EX. <http://192.168.1.100> if HTTP port is 80 or <http://192.168.1.100:800> if HTTP port is 800). The plug-in software in the system will be downloaded and run automatically in the web browser. **Please note that up to 8 users can logon this DVR simultaneously.**

Edge

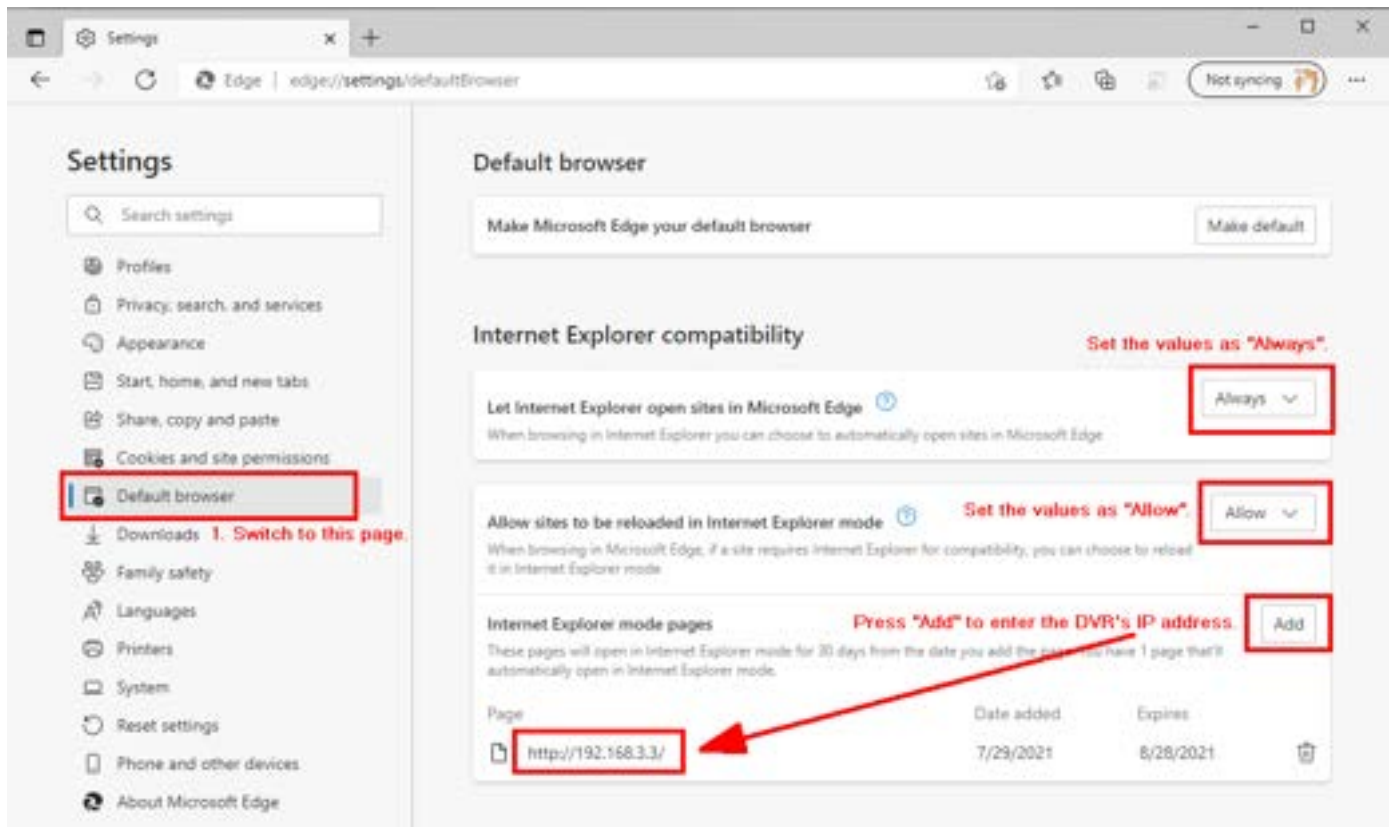
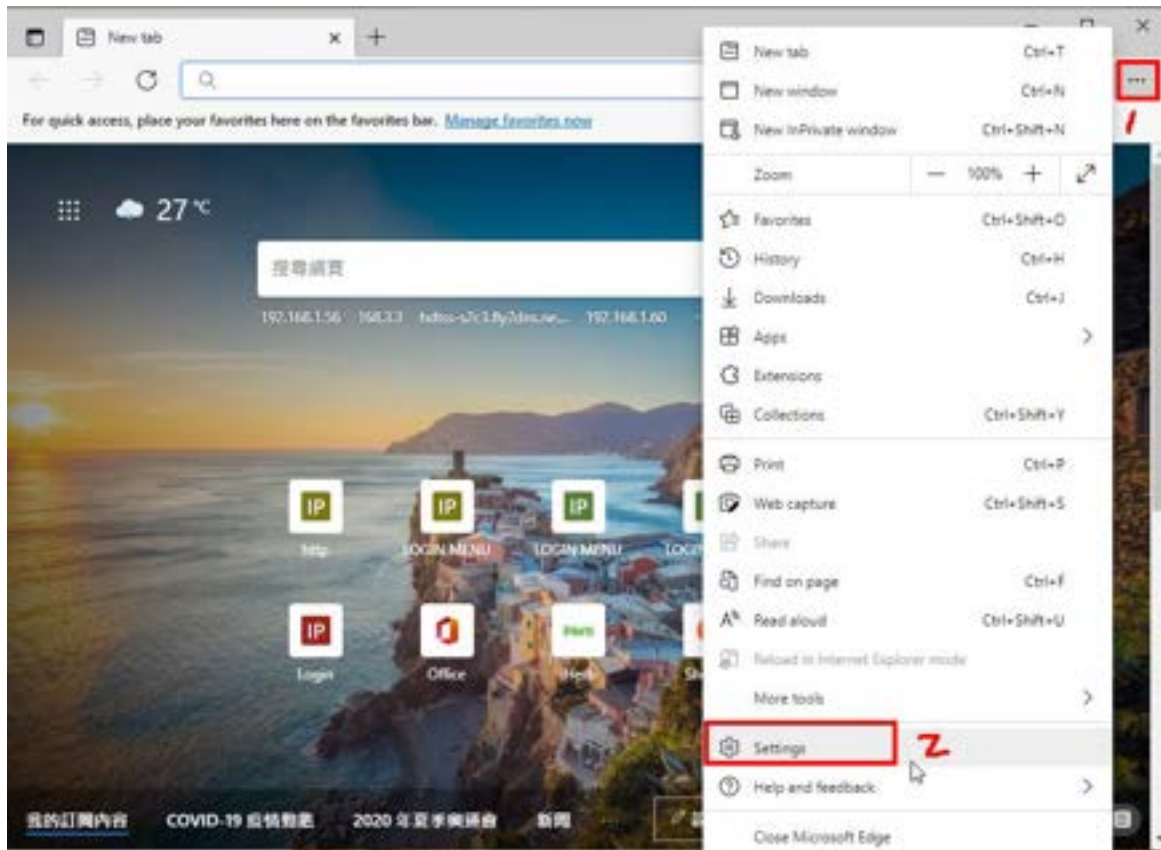

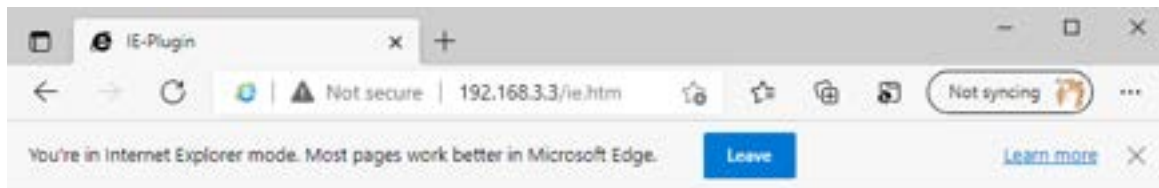

If you connect to the DVR at the first time, you need to install the IE-Plugin first. Please download the manual [package](#), run 'setup.exe' as administrator, and login to the DVR again.
For Google Maps function, you need IE version 11 above.

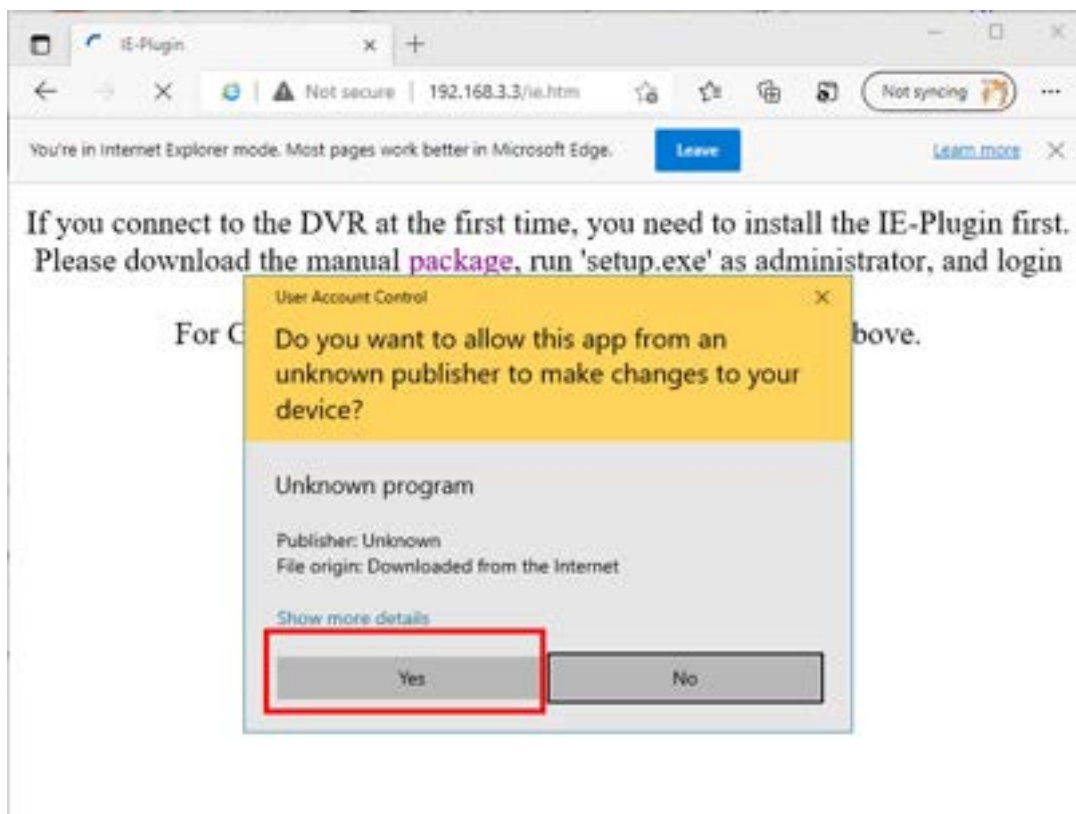

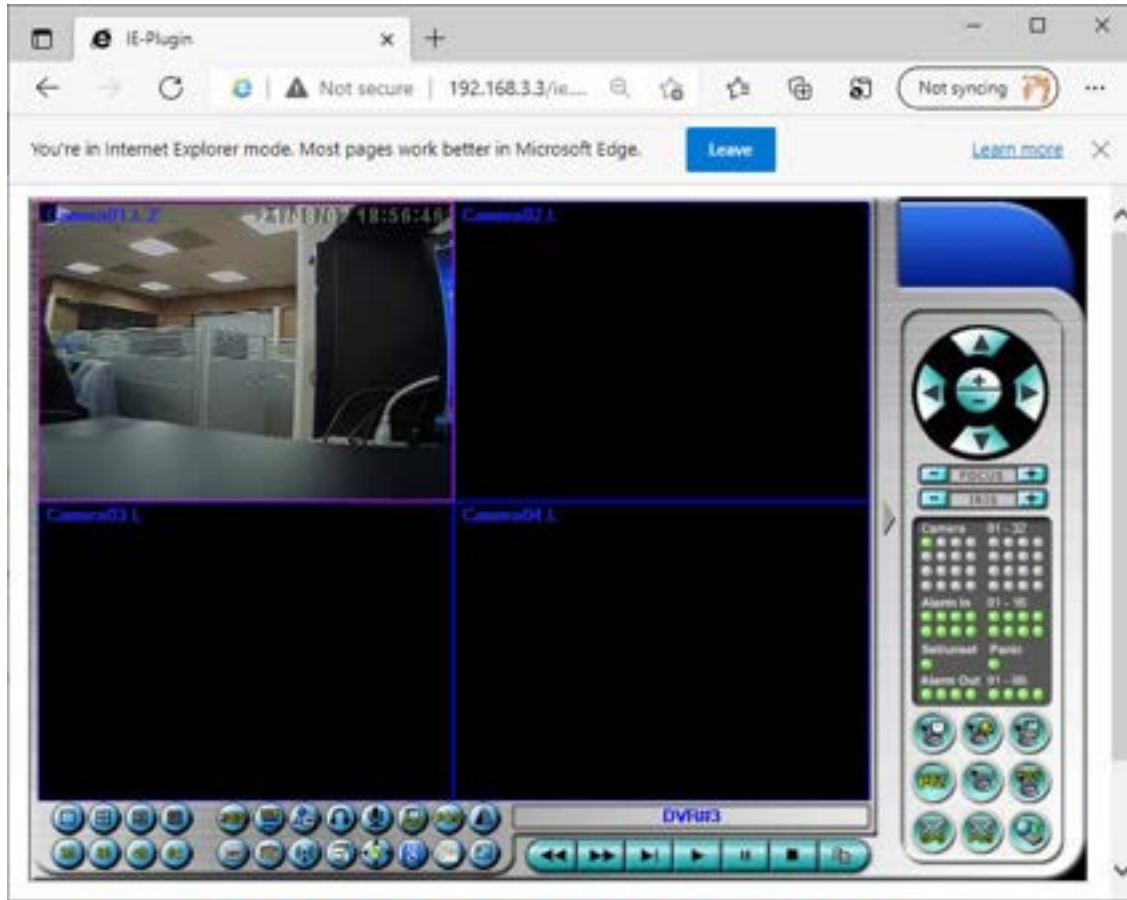
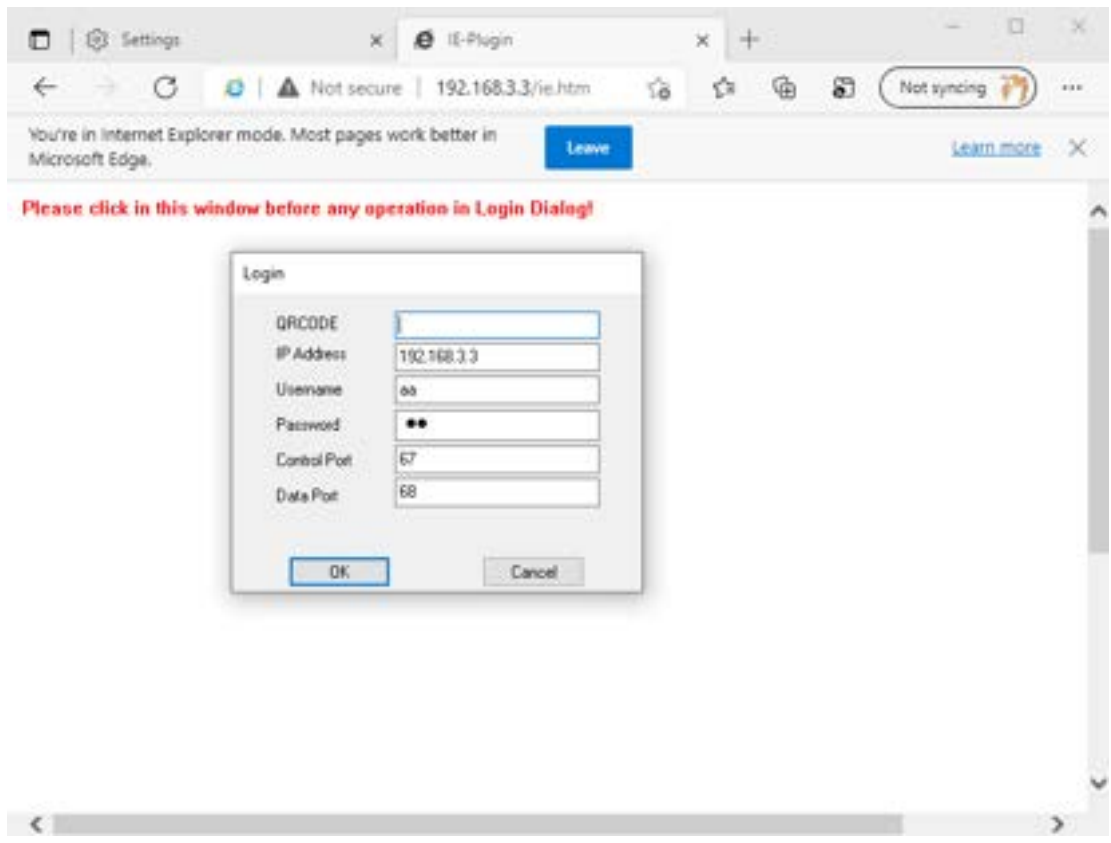

Firefox

To use Firefox to access the DVR, please do the followings:

1. Launch Firefox.
2. Visit the web site "<http://ietab.mozdev.org>" to download and install IE Tab Plugin.
 1. Select Tools → IE Tab Options.
 2. Select Sites Filter.
 3. Check the option "Sites listed here will always render using embedded IE", and add DVR's URL into sites list.

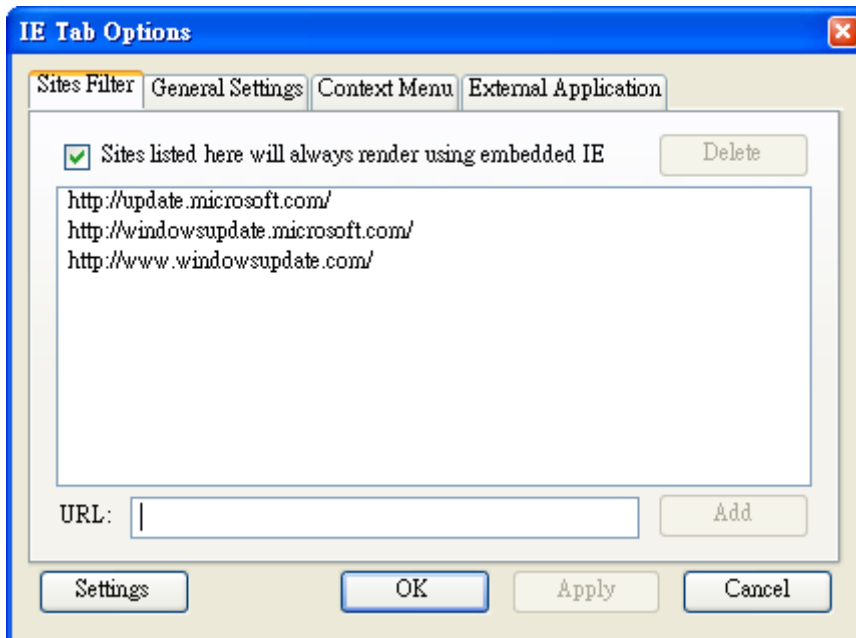

Chrome

- 1.) After downloading Google Chrome browser, go to the Chrome web store and search “IE Tab” for the IE Tab plug-in app. Click on the IE Tab icon for installation page. (please refer to the above figure for reference)



- 2.) Click on the install button to download and install the IE Tab plug-in. Once you have finished downloading, the installation page will refresh and the install button area will show “installed.”



- 3.) After installing the IE Tab plug-in, you will see a small IE icon appear on the top right hand corner. Click on the icon to display your current active page in an IE-based Tab. (please refer to the above figure for reference)



- 4.) Once your page is changed to IE-based display, you may enter your DVRURL or IP address where indicated to log in remotely. (please refer to the above figure for reference)

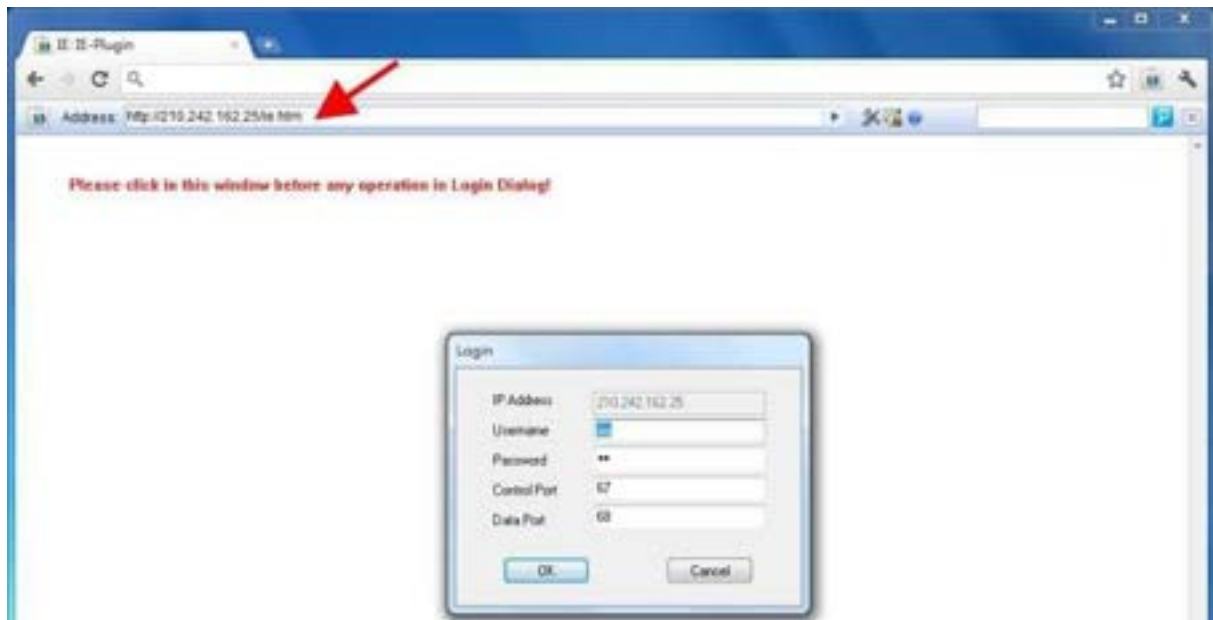

Remote Display and Operations

After the plug-in software is downloaded and run in the web browser, you will be asked (1) to install redistributable software, and (2) for ActiveX control to interact with your PC. Please select Yes, and the remote login display will be shown. **Please note that the PC user must have system administrator password for the PC; otherwise, the process will fail, and an error dialog will be shown.** For some PCs, it may be necessary to click in the window with the message in red color, but outside the Login Dialog before the next step. Please enter the correct login name and password (and control port & data port if they have been changed) for the DVR to login the system. **Please also enter the directory name if multiple profiles were saved.** And the main remote display will be shown as below.



The video images can be displayed in several types of split-window screens, including 1/4/9/16-Window for single DVR and 25/36/49/64 for multiple DVRs. And the focus window is surrounded by a frame border. In addition to the video windows, there are different icons on the lower corner and the right corner of the screen for status display and control. (The “.L” following the camera title stands for Live display, “.P” for Playback, and the camera title with white background has detected motion.)

Note 1: The frame rate is limited by the bandwidth of the network and the pre-record IPS of the camera ([Section 6.1](#)).

Note 2: The picture quality depends on the recording resolution and recording quality of the camera ([Section 6.1](#)).

When the user leaves I.E., he/she may be asked to save changes to files, please enter the directory name (or use default if only one profile is needed), click on OK or Yes to save the changes. The operations and descriptions for these icons are as below:

In video window, right-click the mouse button to call up Camera/Playback/Print Dialog. (Left) click on Playback or Camera number to change the window to the

corresponding camera and live/playback mode. The user may click on the “Print” button to print the video to the printer, or “Snapshot” the video. **The user may also double click for 1-Window display.**



Click on these icons for 1/4/9/16/25/36/49/64-Window display. For 4/9 split windows, the user can click on the icon, and select a different display page.



Click on this icon to switch to or return from SEQ display mode.



Click on this icon to toggle between live mode and playback mode for all the video windows.



Click on this icon to freeze/unfreeze the video images for all the video windows.



Click on this icon to enable/mute the audio input from the PC, button down for enable, button up for mute. If enabled, the audio input from the PC will be sent to the DVR. The default setting is ‘mute’.



Click on this icon to enable/mute the audio output from the camera for the focus window (or DVR), button down for enable, button up for mute.



Click on this icon to show/hide the GPS data for (1) the selected DVR, or (2) the DVR for the focus camera, button down to show, button up to hide.



Click on this icon to show/hide the POS data **(for 9-split-window or larger video window)** for (1) the selected DVR, or (2) the DVR for the focus camera, button down to show, button up to hide.



Click on this icon mirror, flip, or rotate 180 degrees for the video.



Click on this icon to backup video/audio, and the Backup dialog will be shown. Please select the DVR, cameras, event type, destination directory, execution time, and data range, and then click on "Apply" or "OK" to backup, or "Cancel" to cancel. Please note that Execution of "Now" or "Once" is one-time backup, while "Daily" is daily backup.



Click on this icon for snapshot of the focus camera.



Click on this icon for audio broadcasting to all connected DVRs.



Click on this icon to toggle between full screen display and normal IE display.



Click on this icon for full video display (without any icon).



Click on this icon for Google Map display.



Click on this icon for G Sensor Trend Chart display.



Click on these icons to switch the video aspect ratio between 4:3 and 16:9.



Click on this icon to zoom in the video. While enabled, click in the video for 2X, then 4X, and right click to back to 1X.

DVR#3-DP-H.264

The device name of the selected DVR is shown. Click on this icon, and the available DVRs will all be shown. The user may type alphanumeric characters to get the matched DVRs. Click on one of them to select a new DVR. The 1/4/9/16 split-window video display, the camera status, and the alarm input/output will all switch to correspond to the newly selected DVR. There's "Multiple" in the device list, the user can select it to display camera video from different DVRs in 4/9/16 split window display.



Playback panel for playback buttons, including Fast Backward, Fast Forward, Single Step, Play, Pause, Stop, and Copy (from left to right). **Please note that the Copy function can be used to archive both live and playback streams.** Please check/uncheck the cameras to be archived when the Copy Dialog is shown, and then click on OK or Apply button. If the user click on Apply button and select & highlight one of the cameras, the current copying status for that camera will be shown in the dialog.



PTZ control panel. If the camera in the focus window is a PTZ camera, these buttons in the PTZ control panel can be used for PTZ control. The operations include Tilt Up/Down, Pan Left/Right, Zoom In/Out, Focus Near, Focus Far, Iris – (darker), Iris + (brighter).

Camera /

Status indicators for cameras 1-8/4 (GREEN for normal, RED for motion) for the selected DVR. Click on any of these icons to select the corresponding camera of the selected DVR to be displayed in the focus window.

Alarm In /

Status indicators for alarm inputs 1-8 (GREEN for normal, RED for alarm) for the selected DVR.

Alarm Out /

Alarm outputs 1-2 (GREEN for normal state, RED for triggered state) for the selected DVR. For Administrator, click on any of these icons to control the corresponding alarm output from normal to triggered, or from triggered back to normal.



Click on this icon to call up Search-by-time dialog. Please select the time (Year, Month, Date, Hour, and Minute) and recorded video/audio type (Alarm, Motion, Video Loss, and Normal) to search for playback. Click on Search button to start the search of the recorded video/audio. (If it failed, the result will be shown on the title of the dialog.) Now, you may use the playback buttons to play the recorded video/audio. **If there's not any camera in playback mode, all cameras will be searched and played.**

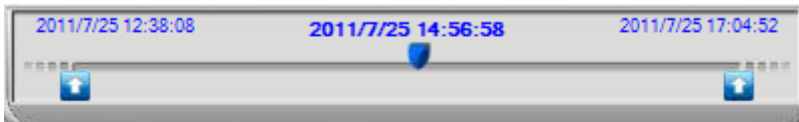

The operations are similar to DVR local operations, except that the user may click on the bottom area of the playback slider to drag it to a different location.



Click on this icon to call up Search-by-event dialog. The event logs will be shown on the screen. Please select the DVR device, event type, and source ID to search for the event logs. Click on Refresh, Up, or Down to update the event logs. Click on the desired event log to highlight and select it. Click on the OK button to search the recorded video/audio for the highlighted event log. Now, you may use the playback buttons to play the recorded video/audio.



Click on this icon to call up search-PC-video dialog. Please select the **file(s)**, and then click on Open. Now, you may use the playback buttons to play the recorded video/audio in the file(s).



Click on this icon to call up POS-Search dialog. Please select the DVR, camera, key word, and start/end time, and click on "Search", then the matched POS data will be shown. Please select the desired POS data, and click on "Backup" or "Play" to backup or play the recorded video/audio corresponding to the POS data.



Click on this icon to show/hide full PTZ control panel. The user can click on the PTZ Panel (but outside of any object in it) (to call up the Context menu) to move it.



Click on this icon to call up Setup dialog. **Unlimited number of DVRs can be added to the device list.**

Following is a brief description for each item:

- **Device Name** – any meaningful name for the (DVR) device.
- **Address** – IP address or URL domain name for the (DVR) device. It should be the same as the IP address (for Static IP) or URL (for PPPoE) in Network Setup for the (DVR) device.
- **Control Port** – the control port for the (DVR) device. The default value is 67.
- **Data Port** – the data port for the (DVR) device. The default value is 68.
- **Video Stream** – “Record” – live video same as recording stream, or “Extra” – extra network stream if dual streaming is supported for the (DVR) device. The default value is “Record”.
- **User Name** – the login user name for the (DVR) device. It must be in the list in Password Setup for the (DVR) device. Please note that **different levels of users have different available operations.**
- **Password** – the corresponding password for the login user name for the (DVR) device.
- **Auto Connection** – whether the user wants to connect automatically to this (DVR) device.
- **Connected** – whether this PC is connected with the (DVR) device now. [If a DVR is connected, the user may select it, and click on “Reboot” to reboot it.](#)

The user can **download/upload** the configurations from/to the connected DVR, or **open/save** the configurations from/to the designated directory.



Click on this icon to call up remote Software Upgrade dialog. [The current software version of the DVR\(s\) will be shown in the “status” field.](#) Please select the DVR device and upgrade file in the PC, and then click on Start button to start the software upgrade process. The Upgrade status will be updated according to the progress. When the upgrade file is uploading, the user may click on Stop/Close button to stop the upgrade process. After the software in the DVR is upgraded, the DVR will restart immediately and the PC will be disconnected from the DVR.

Note: There must be at least one formatted HDD in the DVR for the remote upgrade to succeed.



Click on this icon to call up GPS Configuration dialog. Please select the DVR device. Then select **Displayattributes** and **Outputattributes** for **Live&Playback** respectively.

The display attributes can set whether Google Map displays GPS information, GPS speed, change the color of GPS text, POS display position... etc.If **Data Exchange File** is enabled, the corresponding GPS data will be output to the file specified. Please note that **Tag** and **Icon** are to be used by GPS software such as Google Earth for display purpose.If the **Route** is checked, the output data exchange file will contain the route information. If **COM Port** is enabled, the corresponding GPS data will be output through the specified COM port of the PC. The output data can be used as input by GPS application software such as Google Earth.



Click on this icon to call up POS Configuration dialog. Please select the DVR device. Then select **Video Window or Pop-up Window** to show the POS data. All the other attributes are similar to those for the DVR.

System Requirements of Remote PC

It is recommended to access the digital video/audio recorder using a PC that meets the following system requirements. If you use a PC that does not meet the following system requirements, it may cause problems such as slow imaging or the browser unable to operate.

- **PC**

IBM PC/AT compatible with Intel® Pentium® 4, 1.7 GHz or above CPU.

- **OS**

Microsoft® Windows® 10/8/7.

- **Monitor**

1920 x 1024 or above.

- **Memory (DRAM)**

4096MB or above.

- **Web Browser**

Microsoft® Internet Explorer® 9.0 or above, **32-bit mode**.

- **DirectX**

Microsoft® DirectX® 9.0 or above.

8.2 PDA/Mobile Phone Remote Access (Chrome Wap Mode)

The digital video/audio recorder can also be remotely accessed by using a web browser installed on a PDA or mobile phone that (1) supports **xHTML** and **MJPEG file format**, and (2) has screen resolution at **240x320** or above.

Please enter the domain name or IP address of the digital video/audio recorder in the Location/Address field of the web browser, and the remote login display will be shown. (For most of the mobile devices, the DVR will automatically redirect to the correct web page, EX. <http://192.168.1.89/wap.htm> for IP address <http://192.168.1.89>. If not, please enter the full address with /wap.htm. The user may need to enter <http://192.168.1.89:800/wap.htm> if HTTP port has been changed to 800.) Please enter the correct login name and password for the digital video/audio recorder to login the system, and the screen will be shown as below.



Following is a brief description for each item and its specific operations:



Click on this button to submit the content to the digital video/audio recorder. The new settings will take effect, and the screen will refresh.



Selection of Quad or 1-Window display.



-- for snapshot, **1P-10P for streaming of 1-10FPS (Safari, Firefox)**, **1S-30S for auto-refresh of 1 second to 30 seconds**, **0S for fast auto-refresh that supports HTML4.01.**



: Status indicators for alarm inputs 1-8 (unchecked for normal, checked for alarm).



: Alarm outputs (unchecked for normal, checked for triggered). Administrator can check to trigger the alarm output, uncheck for back to normal.

Appendix A – Time Zone Table

Time Zone	Offset	DST	Start	End
Samoa	GMT – 11:00			
Hawaii	GMT – 10:00			
Alaska	GMT – 09:00	∨	Mar, 2nd Sun, 2:00	Nov, 1st Sun, 2:00
Pacific Time (US & Canada)	GMT – 08:00	∨	Mar, 2nd Sun, 2:00	Nov, 1st Sun, 2:00
Arizona, US Mountain	GMT – 07:00			
Chihuahua, La Paz, Mazatlan	GMT – 07:00	∨	May, 1st Sun, 2:00	Sep, last Sun, 2:00
Mountain Time (US & Canada)	GMT – 07:00	∨	Mar, 2nd Sun, 2:00	Nov, 1st Sun, 2:00
Central America, Saskatchewan	GMT – 06:00			
Central Time (US & Canada)	GMT – 06:00	∨	Mar, 2nd Sun, 2:00	Nov, 1st Sun, 2:00
Guadalajara, Mexico City, Monterrey	GMT – 06:00	∨	May, 1st Sun, 2:00	Sep, last Sun, 2:00
Bogota, Lima, Quito, Indiana (East)	GMT – 05:00			
Eastern Time (US & Canada)	GMT – 05:00	∨	Mar, 2nd Sun, 2:00	Nov, 1st Sun, 2:00
Atlantic Time (Canada)	GMT – 04:00	∨	Mar, 2nd Sun, 2:00	Nov, 1st Sun, 2:00
Caracas, La Paz	GMT – 04:00			
Santiago	GMT – 04:00	∨	Oct, 2nd Sun, 0:00	Mar, 2nd Sun, 0:00
Newfoundland	GMT – 03:30	∨	Apr, 1st Sun, 2:00	Oct, last Sun, 2:00
Brasilia	GMT – 03:00	∨	Oct, 3rd Sun, 2:00	Feb, 3rd Sun, 2:00
Buenos Aires, Georgetown	GMT – 03:00	∨	Oct, 3rd Sun, 2:00	Feb, 2nd Sun, 2:00
Greenland	GMT – 03:00	∨	Mar, last Sun, 1:00	Oct, last Sun, 1:00
Mid-Atlantic	GMT – 02:00	∨	Mar, last Sun, 2:00	Sep, last Sun, 2:00
Azores	GMT – 01:00	∨	Mar, last Sun, 2:00	Oct, last Sun, 3:00
Cape Verde	GMT – 01:00			
Casablanca, Monrovia	GMT + 00:00			
Dublin, London	GMT + 00:00	∨	Mar, last Sun, 1:00	Oct, last Sun, 2:00
Western Europe, Central Europe	GMT + 01:00	∨	Mar, last Sun, 2:00	Oct, last Sun, 3:00
West Central Africa	GMT + 01:00			
Eastern Europe	GMT + 02:00	∨	Mar, last Sun, 0:00	Oct, last Sun, 1:00
Cairo	GMT + 02:00	∨	Apr, last Fri, 2:00	Sep, last Fri, 2:00
Harare, Pretoria	GMT + 02:00			
Helsinki, Kyiv, Riga, Sofia, Tallinn	GMT + 02:00	∨	Mar, last Sun, 2:00	Oct, last Sun, 3:00
Jerusalem	GMT + 02:00	∨	Apr 1, 2:00	Oct, 2nd Sun, 2:00
Baghdad	GMT + 03:00	∨	Apr 1, 3:00	Oct 1, 4:00
Kuwait, Riyadh, Nairobi	GMT + 03:00			
Moscow, St. Petersburg, Volgograd	GMT + 03:00	∨	Mar, last Sun, 2:00	Oct, last Sun, 3:00
Tehran	GMT + 03:30	∨	Mar, 4th Tue, 2:00	Sep, 4th Thu, 2:00
Abu Dhabi, Muscat	GMT + 04:00			
Baku, Tbilisi, Yerevan	GMT + 04:00	∨	Mar, last Sun, 2:00	Oct, last Sun, 3:00
Time Zone	Offset	DST	Start	End
Kabul	GMT + 04:30			
Ekaterinburg	GMT + 05:00	∨	Mar, last Sun, 2:00	Oct, last Sun, 3:00
Islamabad, Karachi, Tashkent	GMT + 05:00			

Chennai, Mumbai, New Delhi	GMT + 05:30			
Kathmandu	GMT + 05:45			
Almaty, Novosibirsk	GMT + 06:00	∨	Mar, last Sun, 2:00	Oct, last Sun, 3:00
Astana, Dhaka, Sri Lanka	GMT + 06:00			
Rangoon	GMT + 06:30			
Bangkok, Hanoi, Jakarta	GMT + 07:00			
Krasnoyarsk	GMT + 07:00	∨	Mar, last Sun, 2:00	Oct, last Sun, 3:00
Irkutsk, Ulaan Bataar	GMT + 08:00	∨	Mar, last Sun, 2:00	Oct, last Sun, 3:00
Beijing, Chingqing, H. K., Urumqi	GMT + 08:00			
Kuala Lumpur, Perth, Singapore	GMT + 08:00			
Taipei	GMT + 08:00			
Osaka, Seoul, Tokyo	GMT + 09:00			
Yakutsk	GMT + 09:00	∨	Mar, last Sun, 2:00	Oct, last Sun, 3:00
Adelaide	GMT + 09:30	∨	Oct, last Sun, 2:00	Mar, last Sun, 3:00
Darwin	GMT + 09:30			
Brisbane, Guam, Port Moresby	GMT + 10:00			
Canberra, Melbourne, Sydney	GMT + 10:00	∨	Oct, last Sun, 2:00	Mar, last Sun, 3:00
Hobart	GMT + 10:00	∨	Oct, 1st Sun, 2:00	Mar, last Sun, 3:00
Vladivostok	GMT + 10:00	∨	Mar, last Sun, 2:00	Oct, last Sun, 3:00
Magadan, Solomon Is.	GMT + 11:00			
Auckland, Wellington	GMT + 12:00	∨	Oct, 1st Sun, 2:00	Mar, 3rd Sun, 2:00
Fiji	GMT + 12:00			
Kamchatka	GMT + 12:00	∨	Mar, last Sun, 2:00	Oct, last Sun, 3:00
Anadyr	GMT + 13:00	∨	Mar, last Sun, 2:00	Oct, last Sun, 3:00
Nuku'alofa	GMT + 13:00			

Appendix B – MS-Windows HEM Utilities

The remote CMS software (**HEM**), and the MS-Windows utility programs (**HEM Utilities**) include **HEM**, **HEM Player**, **Media Converter**, **Keyboard Control Simulator**, and **DVR Browser**. Please contact your local dealer or contractor to get the **HEM** and **HEM Utilities** applications. Unzip them and double click on **HEM/Setup.exe** to install HEM, and **Utilities/Setup.exe** to install the utility programs. Please follow the instructions on the screen to install the software in the default directory “Program Files\Hyper Electronics Mappers” or the directory entered by the user. For HEM, please refer to the manual for HEM. For the other utility programs, please refer to the following paragraphs.

HEM Player

Before running **HEM Player** in your PC, please make sure the followings:

1. **DirectX® End-User Runtime 9.0** or above has been installed in your PC successfully. If not, please logon to <http://www.microsoft.com> to get the free download of it.
2. Please go to Start → Setup → Control, select Display → Settings, and set the Screen Resolution to at least 1920x1024 and Color to 32-bit.

To run the **HEM Player** under MicroSoft® Windows®, please select Start → Programs → Hyper Electronics Mappers → HemPlayer, and the screen will be shown as below.



Since this utility is a free player utility for the archived files, from USB backup or remote backup, some of the functions are disabled. The mouse cursor will change to “Hand” type if it’s on those enabled function icons. The operations and their descriptions are the same as in [Chapter 8. Remote Access](#).

To select an archived file for playback, please click on **File** menu, and then select **Open**. After an archived file is opened, the user may click on the player buttons to play the file.

The following diagram shows the screen after the **Play** button is pressed.



The user may print the whole player screen (including the current video image) or the current video image by selecting **File** menu, and then select **Print** or **Print Video** respectively.

Keyboard Control Simulator

To run the **Keyboard Control Simulator** under MS-Windows, please select Start → Programs → Hyper Electronics Mappers → KCtrlSimulator, and the screen will be shown as below.

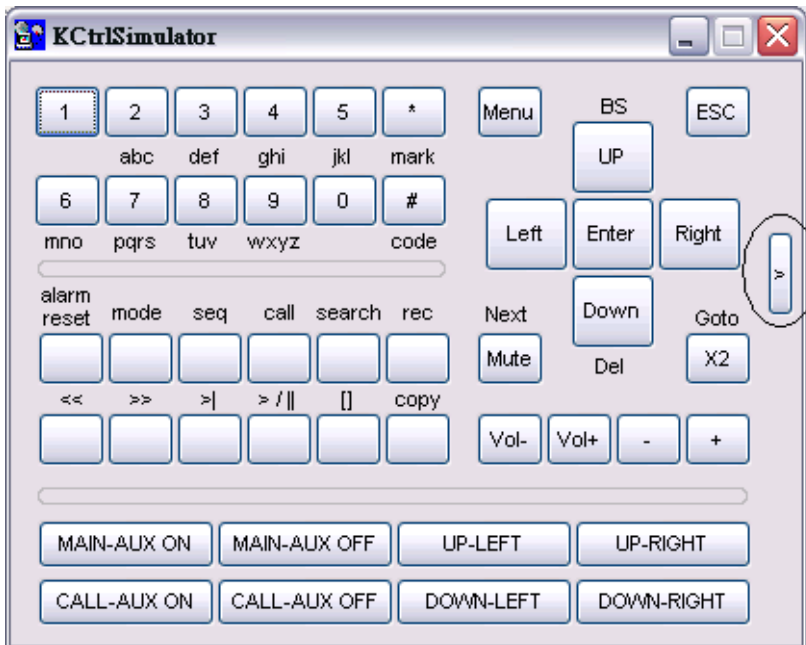

Please note that most of the buttons correspond to the keypads on the front panel. If you connect the PC through RS-232 and use an RS-232/RS-485 converter to connect to multiple DVRs, you would be able to control multiple DVRs via the simulation software. Please refer to [Section 3.2 Optional Connections](#) to connect/cascade the DVRs to the PC.

To select the DVR to control, please click on the button as circled in the above diagram to set the corresponding DVR ID. Please note that the [RS-232/485 setup \(Section 6.8\)](#), including the **DVR ID**, in the DVRs must be configured correctly (**Model** must be set as **Control Protocol**).

Note: **UP-LEFT**, **UP-RIGHT**, **DOWN-LEFT**, and **DOWN-RIGHT** are newly added to control the PTZ cameras diagonally.

Video/H.265/H.264 to AVI/MP4 Conversion Utility

To run the **Video/H.265/H.264 to AVI/MP4 Conversion Utility** under MS-Windows, please select Start → Programs → Hyper Electronics Mappers → Media Converter or double-click on the file **Media_Converter.EXE**, and the screen will be shown as below.

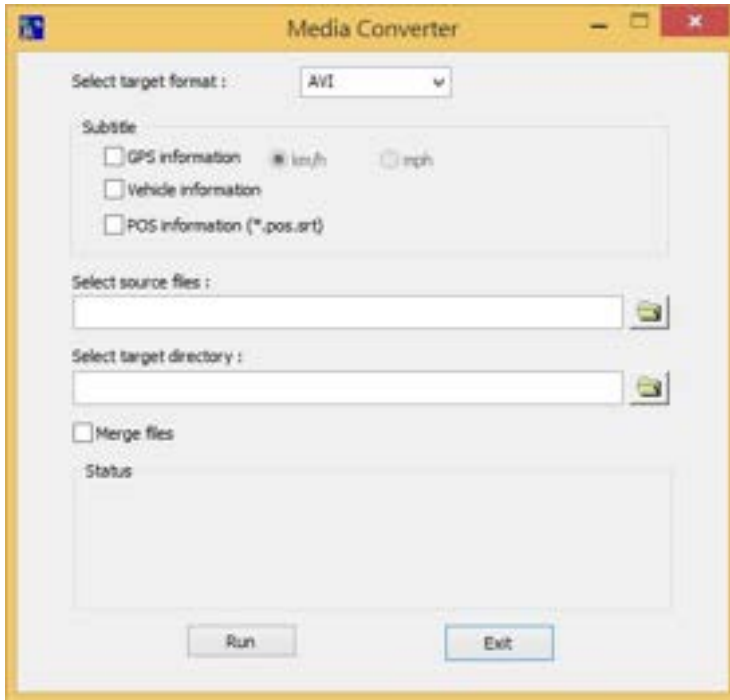

Please select the **target format – AVI or MP4**, the source files – **.Video/H265/H264** files archived from DVR, remote I.E., HEM, and FTP file transfer – to be converted from, the target directory to save the converted files, and check “Merge files” if you want **chained backup files to be converted into one AVI/MP4 file**, and then click on **OK** to do the conversion. If there’s POS/GPS data for the files, please check the related items in [Subtitle]. **The converted .AVI or .MP4 files can be played by Windows Media Player if DivX (<http://www.divx.com/>) or the other H.265/264 decoder is installed in the PC.**

To display subtitle in Media Player, please refer to <http://www.brighthub.com/computing/windows-platform/articles/41466.aspx> and logon to <http://www.videohelp.com/software/VFilter-DirectVobSub> to download and install **VFilter / DirectVobSub**. In Media Player, right click to display the menu and select [Lyrics, captions and subtitles] → [On if available] and enable it.

To display subtitle in VLC Player, please select [Tools] → [Preferences] → [Subtitles/OSD] and check [Enable subtitles].

DVR Browser Utility

To run the **DVR Browser Utility** under MS-Windows, please select Start → Programs → Hyper Electronics Mappers → DVR Browser or double-click on the file **DVR_Browser.EXE**, and the screen will be shown.

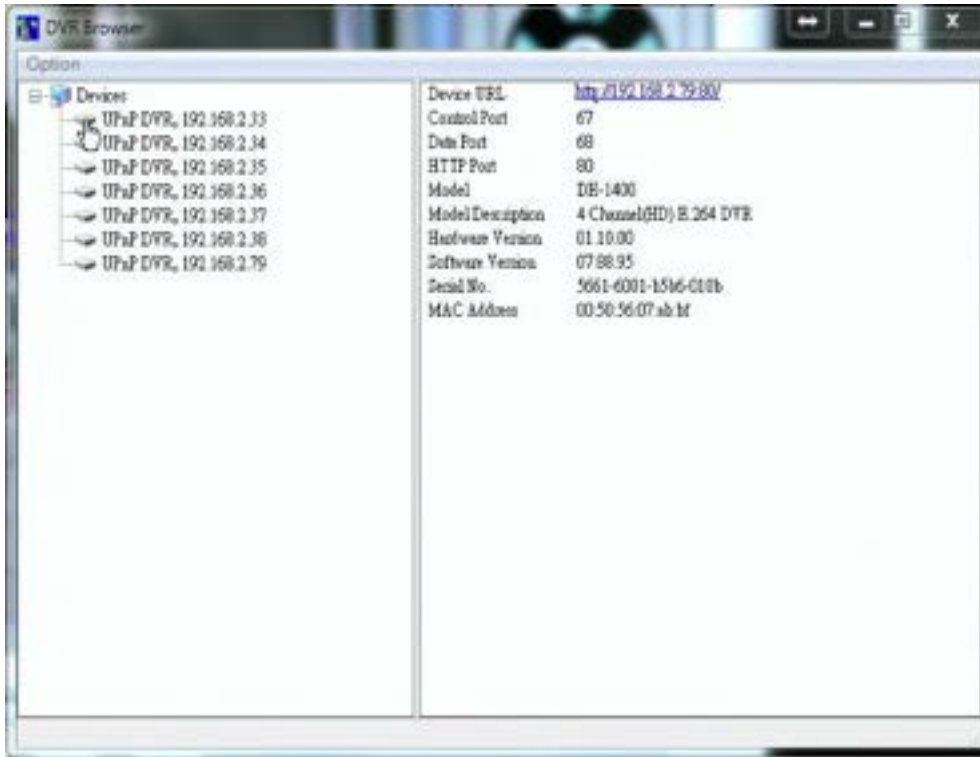

The utility will scan all the DVRs which support UPnP in the LAN. Please select the desired DVR device, and its detailed information will be shown on the right as above. Users can (1) click on the URL to call up IE and logon to the device, (2) select Option → Rescan network, or (3) select Option → Export Device List. The exported device list can be imported to IE software or CMS software in the future.

Appendix C – GPS Function in Remote Software with Google Earth

The GPS output for the DVR and its remote software can be used by GPS software such as Google Earth. The user may use the following paragraphs as an example.

1. Open remote software such as IE Browser, and log on to the DVR or open and playback the archived file with GPS information.



2. Select GPS Configuration ().
3. Enable Output with Data Exchange File, and set the related items (File, Tag, & Icon).

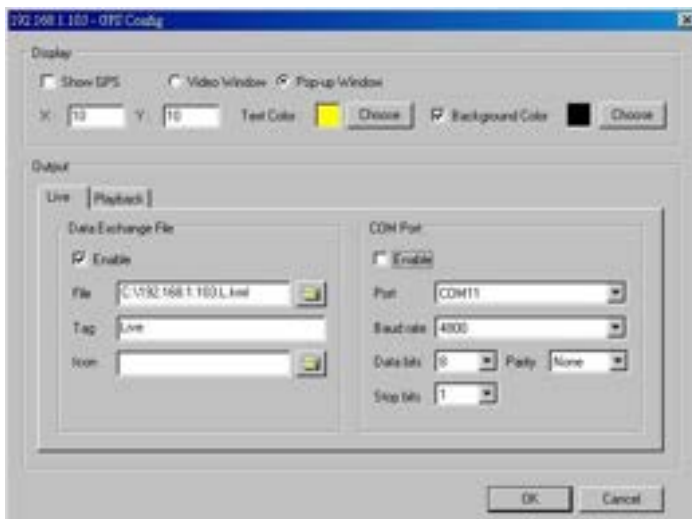

4. Open Google Earth.

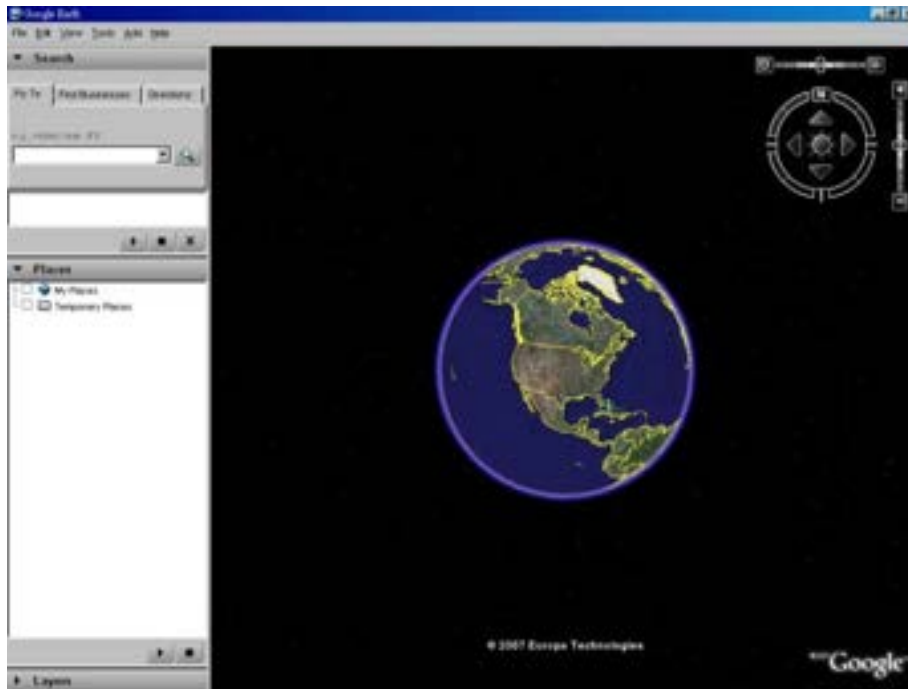

5. Add Network Link.

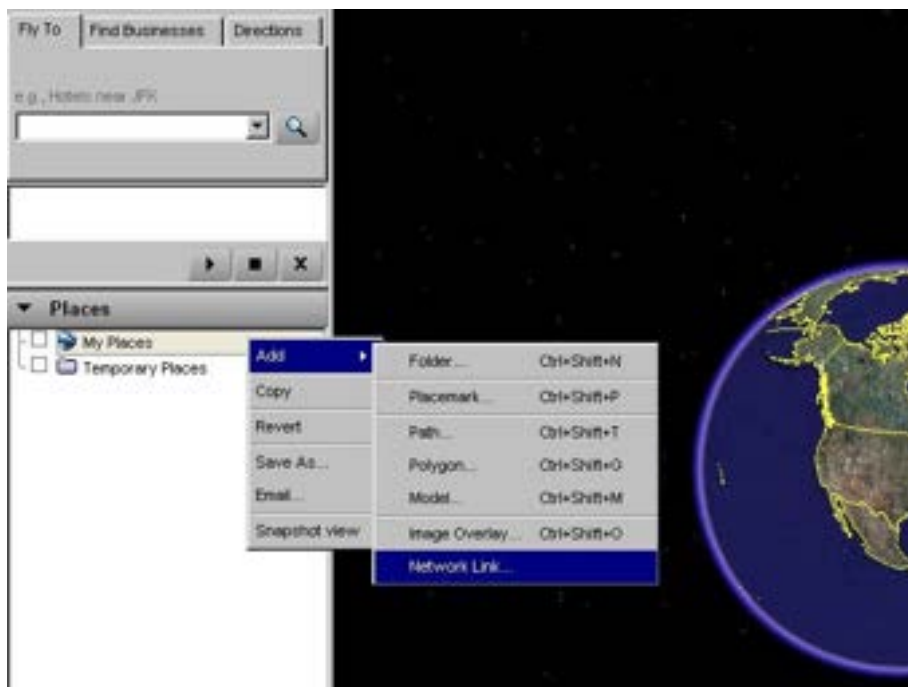

6. Select the Data Exchange File in the remote software as Link. **Please note that the directory & filename MUST be in English for old version of Google Earth to work correctly.**



7. Set Time-Based Refresh.

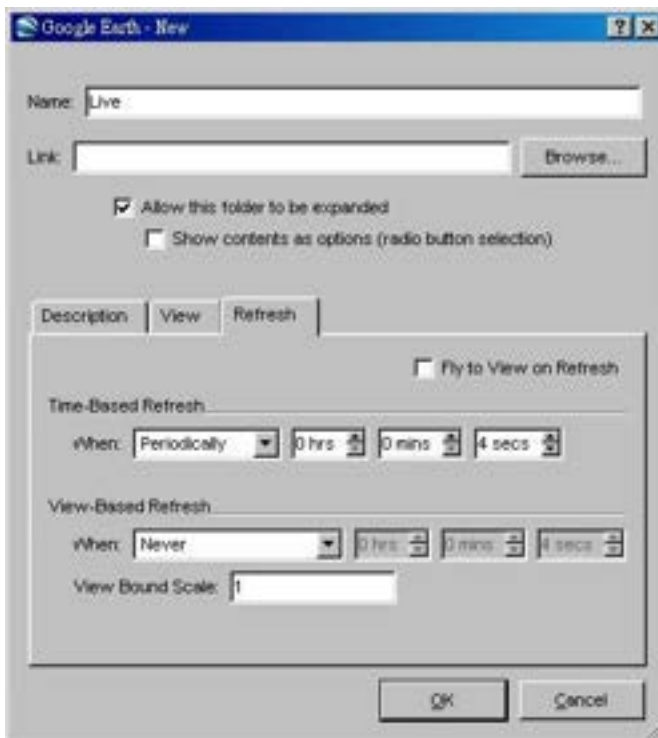

8. Click on OK button to save the settings.

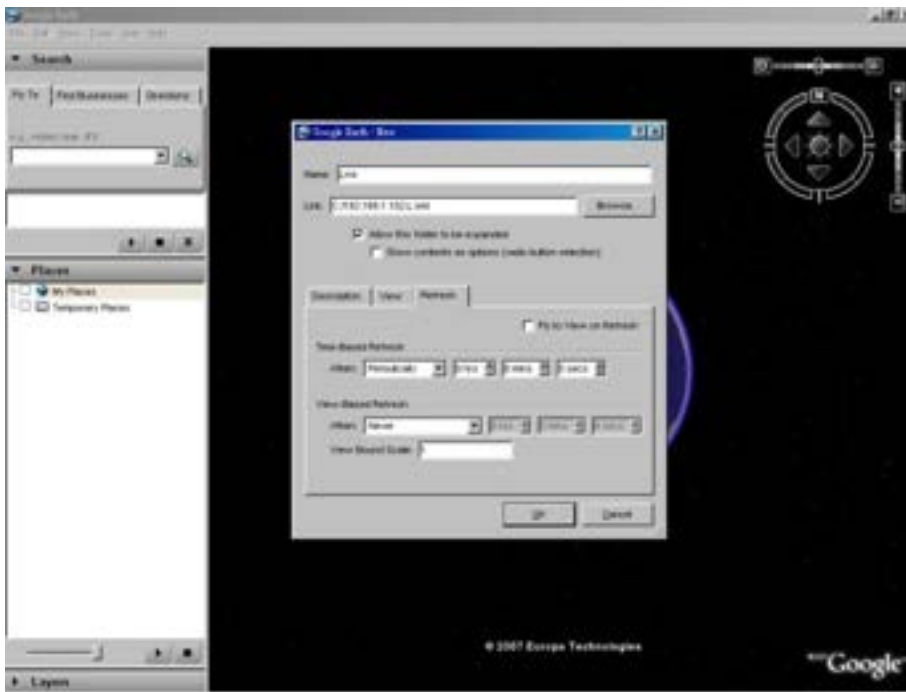

9. Now, the GPS data will be fed from the DVR remote software to Google Earth, and the GPS position will be continuously updated in Google Earth.

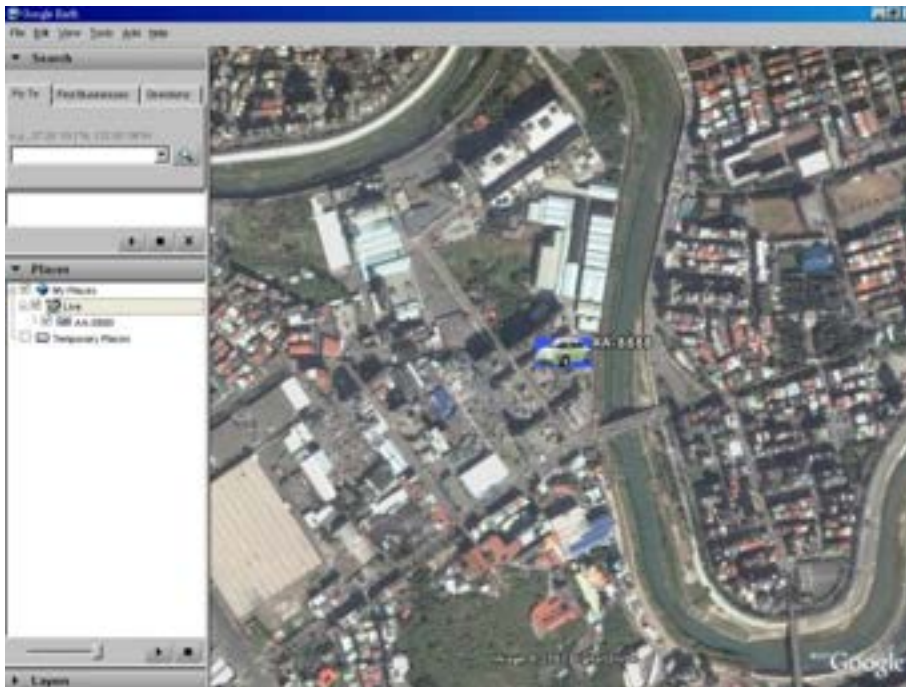

Appendix D – Protocol Converter for Multiple POS

Multiple POS devices can be connected through the RS-232 port of the DVR. Please refer to [Section 3.2 Optional Connections](#) for the connections. Please refer to page 22/23 of 7524 Hardware User's Manual for the pin assignment of I-7523, which is similar to protocol converter I-7524.

Please note that the RS-485 module address of the protocol converter must be 1, 5, 9 or 13(Hex 0D), and the addresses of the POS devices connected are 1/2/3/4, 5/6/7/8, 9/10/11/12, and 13/14/15/16 respectively. The corresponding cameras for POS device addresses 1/2/3/4/5/6/7/8/9/10/11/12/13/14/15/16 are cameras 1/2/3/4/5/6/7/8/9/10/11/12/13/14/15/16.

The default RS-485 module address of the protocol converter is **1**. If the user wants to change the RS-485 module address of the protocol converter to **5/9/13**, please do the following steps:

1. **Connect the protocol converter to the RS-485 network of a host PC.** (Please refer to page 9 in I-7524 Software User's Manual. RS-232-to-RS-485 converter can be used in place of 7520.)
2. Execute **7188X.EXE** in the host PC. (Please uncompress the file \Napdos\MiniOS7\utility\7188xw_20050127.zip in the bundled 7000/7188/8000 CD to get the executable.)
3. **Select the active COM port** of the host PC by pressing **Alt-1** for COM1 or **Alt-2** for COM2.
4. Change the baud rate to 38400 by pressing **Alt-C** first, then enter **b38400** to **set baud rate to 38400**.
5. Change to Line-Command-Mode by pressing **Alt-L**.
6. **Change the RS-485 module address by entering \$01AXX.** (**01** is the original module address, **XX** is the new module address such as **01/05/09/0D**.)

Please note that the other settings for the protocol converter are Baud Rate = 38400, Data Bit = 8, Stop Bit = 1, and Parity = None. Those settings cannot be changed, and have nothing to do with the RS-232/422/485 Setup (which is related to the settings of the POS printers connected).